

VALOR

SPECIALTY PRODUCTS INC.

BUILDING
PRODUCT
Price List

Effective Jan. 1, 2017



Make the ULTIMATE First Impression in your neighbourhood!

www.valor.ca

PRODUCT Index

Section 1 - Shutters

Custom Size Vinyl Shutters
Shutter Accessories

Pages

1 - 3
4

Section 2 - Fiberglass Columns

Fiberglass Pultruded Columns
Caps, Bases, and Accessories
Fiberglass Round Tapered Columns

1
2 - 3
4

Section 3 - Millwork

PVC Trim Boards
PVC Sheet Goods
PVC J-Pocket Trim & Skirtboards
PVC Trims, Corners, Etc.
PVC Extruded Mouldings
PVC Mounting Blocks
PVC Custom Shutters
PVC Gable Accents
PVC Square Plain Straight Column Wraps
PVC Square Fluted Straight Column Wraps
PVC Square Raised Panel Straight Column Wraps
PVC Square Recessed Panel Straight Column Wraps
PVC Square Tapered Column Wraps
PVC Square Column Piers
PVC Square Post Wrap Accessories
PVC Louvers
PVC Wall Accents/Sunbursts
PVC Headers - 5.5" and 7.25"
PVC Pilasters
PVC Mouldings
PVC Brackets & Accents

1
2
3
4
5 - 6
7
8 - 10
11 - 22
23
24
25
26
27
28
29
30 - 32
33 - 35
36 - 39
40 - 41
42
43-44

Section 4 - Other

Custom PVC Products
Paint Services
Terms & Conditions

1-2
3
4-5

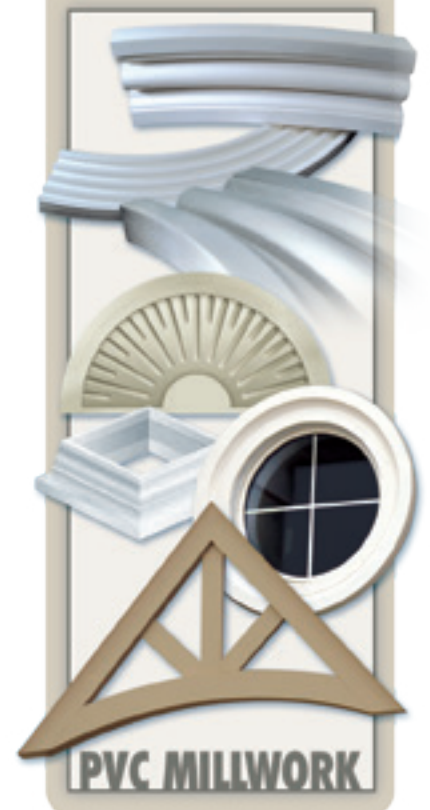

Make the ULTIMATE First Impression in your neighbourhood!

www.valor.ca

VALOR

SPECIALTY PRODUCTS INC.

Custom Size Vinyl Shutters

...made to order



LOUVER



PANEL

Valor Exterior Decorative Shutters are manufactured from a durable polypropylene compound with the colour moulded right into the plastic. Wood grain texture and beaded detailing give our shutters an elegant look, and are available in many styles to suit virtually any home. Although our shutters are custom made to size; because they are constructed using both extruded and moulded parts it's necessary to pay attention to the minimum and maximum lengths and width availability for each style.



BOARD & BATTEN



Make the ULTIMATE First Impression in your neighbourhood!

www.valor.ca

VALOR SPECIALTY PRODUCTS INC.

1800 Courtneypark Dr. East, Units 2-4
Mississauga, ON Canada L5T 1W1

TEL: (905) 564-3122 • FAX: (905) 564-5470



SPECIALTY PRODUCTS INC.

Custom Size Vinyl Shutters

...made to order



Fasteners Included

12 - 2-1/2" zinc screws with colour matched plastic caps are included with installation instructions. If installing into masonry, #8 nylon anchors will be required (*not included*). Shutter Lock Plastic Fasteners can be purchased as an option if desired, which eliminate the need for anchors.

Painting Shutters

A "PAINTABLE" VERSION IS AVAILABLE, it is a different type of plastic and MUST be specified when ordering. Please indicate "PAINTABLE" where a colour would normally be specified. We recommend a light exterior grade primer, and a quality exterior acrylic paint. Our coloured shutters CAN NOT BE PAINTED. The durable material does not allow paint to adhere.

Warranty

VALOR Custom Shutters come with a 40 year limited warranty, that covers excessive fading, cracking, and peeling, etc. The warranty covers only the cost of the product.



Ordering

For additional ordering information, visit www.valor.ca/downloads/Shutter.Ordering.Info.pdf



COLOURS AVAILABLE

WHITE (WH/01) 	FOREST GREEN (FG/28) 	BORDEAUX (BDX/167) 	MIDNIGHT GREEN (MG/122) 
BRIGHT WHITE (BWH/117) 	BURGUNDY (BU/27) 	WICKER (WKR/23) 	FEDERAL BROWN (FBR/09) 
PAINTABLE (PT/30) 	BLACK (BK/02) 	CLAY (CL/08) 	MUSKET BROWN (MBR/10) 
WEDGEWOOD BLUE (WBL/04) 	TUXEDO GREY (TGR/18) 	CLASSIC BLUE (CB/36) 	WINEBERRY (WY/78) 
MIDNIGHT BLUE (MBL/166) 			

Make the ULTIMATE First Impression in your neighbourhood!

www.valor.ca

VALOR SPECIALTY PRODUCTS INC.

1800 Courtneypark Dr. East, Units 2-4
Mississauga, ON Canada L5T 1W1

TEL: (905) 564-3122 • FAX: (905) 564-5470



SPECIALTY PRODUCTS INC.

Custom Size Vinyl Shutters

...made to order

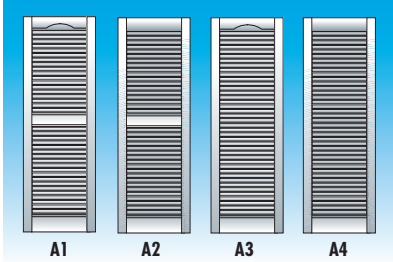

A LOUVER

- A1** ARCH TOP w/ Centre Bar
- A2** STRAIGHT TOP w/ Centre Bar
- A3** ARCH TOP w/o Centre Bar
- A4** STRAIGHT TOP w/o Centre Bar

CAT: SHVL	A - LOUVERED	PRICE	
		STANDARD	PREMIUM
15.00" - 36"	SHV-A??-036	95.74	125.73
36.25" - 39"	SHV-A??-039	100.83	130.82
39.25" - 43"	SHV-A??-043	109.44	139.43
43.25" - 48"	SHV-A??-048	120.09	150.08
48.25" - 52"	SHV-A??-052	128.72	158.71
52.25" - 55"	SHV-A??-055	136.46	166.44
55.25" - 60"	SHV-A??-060	147.16	177.14
60.25" - 64"	SHV-A??-064	155.72	185.70
64.25" - 67"	SHV-A??-067	162.18	192.16
67.25" - 72"	SHV-A??-072	172.85	202.84
72.25" - 75"	SHV-A??-075	179.29	209.28
75.25" - 79"	SHV-A??-079	187.80	217.78
79.25" - 87"	SHV-A??-087	204.91	234.92
87.25" - 96"	SHV-A??-096	224.24	254.23
96.25" - 108"	SHV-A??-108	251.29	281.27
108.25" - 120"	SHV-A??-120	275.63	305.64
120.25" - 144"	SHV-A??-144	327.00	356.98

Standard Widths:
9.25", 12" and 14.5" widths

Premium Widths:
16.5" and 18" widths

Lengths: Minimum: 15"
Maximum: 144". Order any length from 15" to 144" in 1/4" increments.

A3 & A4 Style Shutters may be +/- 1/2" from length ordered.

All shutter prices are per pair.

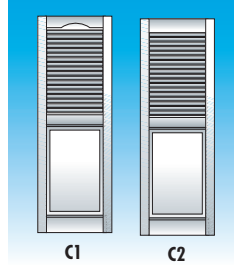

C LOUVER-OVER-PANEL

- C1** LOUVER OVER PANEL ARCH TOP
- C2** LOUVER OVER PANEL STRAIGHT TOP

CAT: SHVP	C - LOUVERED OVER PANEL	PRICE	
		STANDARD	PREMIUM
18.00" - 36"	SHV-C??-036	163.05	187.72
36.25" - 39"	SHV-C??-039	171.61	198.77
39.25" - 43"	SHV-C??-043	183.03	213.49
43.25" - 48"	SHV-C??-048	197.33	231.93
48.25" - 52"	SHV-C??-052	208.75	246.65
52.25" - 55"	SHV-C??-055	217.31	257.70
55.25" - 60"	SHV-C??-060	231.60	276.13
60.25" - 64"	SHV-C??-064	243.03	290.85
64.25" - 67"	SHV-C??-067	251.61	301.90
67.25" - 72"	SHV-C??-072	268.07	322.51
72.25" - 75"	SHV-C??-075	274.46	331.39
75.25" - 79"	SHV-C??-079	285.89	346.11
79.25" - 87"	SHV-C??-087	308.74	375.59
87.25" - 96"	SHV-C??-096	334.46	408.75
96.25" - 110"	SHV-C??-110	374.45	460.31

Standard Widths:
9.25", 12" and 14.5" widths

Premium Widths:
16.5" and 18" widths

Lengths: Minimum: 18"
Maximum: 110". Order any length from 18" to 110" in 1/4" increments.

All shutter prices are per pair.

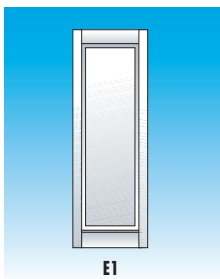

E ONE PANEL

- E1** ONE PANEL STRAIGHT TOP

CAT: SHVP	E - ONE PANEL	PRICE	
		STANDARD	PREMIUM
18.00" - 36"	SHV-E??-036	163.62	192.74
36.25" - 39"	SHV-E??-039	175.12	207.25
39.25" - 43"	SHV-E??-043	190.44	226.59
43.25" - 48"	SHV-E??-048	209.60	250.76
48.25" - 52"	SHV-E??-052	224.92	270.09
52.25" - 55"	SHV-E??-055	236.42	284.59

Standard Widths:
9.25", 12" and 14.5" widths

Premium Widths:
16.5" and 18" widths

Lengths: Minimum: 18"
Maximum: 55". Order any length from 18" to 55" in 1/4" increments.

All shutter prices are per pair.

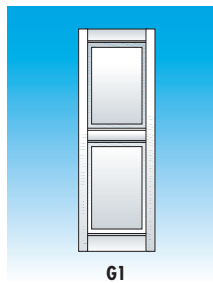

G TWO PANEL

- G1** TWO PANEL STRAIGHT TOP

CAT: SHVP	G - TWO PANEL	PRICE	
		STANDARD	PREMIUM
22.00" - 36"	SHV-G??-036	188.37	217.61
36.25" - 39"	SHV-G??-039	199.87	232.13
39.25" - 43"	SHV-G??-043	215.19	251.46
43.25" - 48"	SHV-G??-048	234.35	275.63
48.25" - 52"	SHV-G??-052	249.66	294.97
52.25" - 55"	SHV-G??-055	261.16	309.46
55.25" - 60"	SHV-G??-060	280.32	333.63
60.25" - 64"	SHV-G??-064	295.64	352.97
64.25" - 67"	SHV-G??-067	307.14	367.46
67.25" - 72"	SHV-G??-072	326.27	391.63
72.25" - 75"	SHV-G??-075	337.77	406.13
75.25" - 79"	SHV-G??-079	353.09	425.46
79.25" - 87"	SHV-G??-087	383.75	464.15
87.25" - 96"	SHV-G??-096	418.23	507.66
96.25" - 110"	SHV-G??-110	471.86	575.31

Standard Widths:
9.25", 12" and 14.5" widths

Premium Widths:
16.5" and 18" widths

Lengths: Minimum: 22"
Maximum: 110". Order any length from 22" to 110" in 1/4" increments.

All shutter prices are per pair.





SPECIALTY PRODUCTS INC.

Custom Size Vinyl Shutters

...made to order

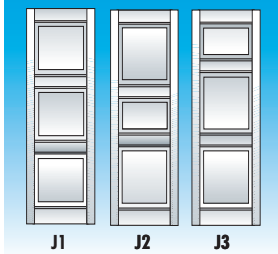

- J THREE PANEL**
- J1 EQUAL SIZE PANELS
 - J2 SMALLER MIDDLE PANEL
 - J3 SMALLER TOP PANEL

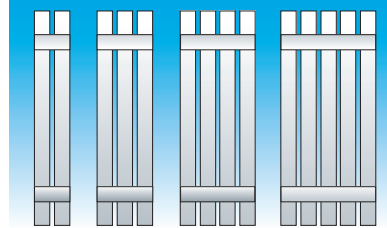

- L BOARD & BATTEN SPACED BOARDS**
- AVAILABLE IN
2, 3, 4 AND 5 SLATS
(Depending on size requirements)

CAT: SHVP	J - THREE PANEL	PRICE	
		STANDARD	PREMIUM
33.00" - 36"	SHV-J??-036	276.23	305.59
36.25" - 39"	SHV-J??-039	287.73	320.11
39.25" - 43"	SHV-J??-043	303.05	339.45
43.25" - 48"	SHV-J??-048	322.21	363.62
48.25" - 52"	SHV-J??-052	337.52	382.95
52.25" - 55"	SHV-J??-055	349.03	397.42
55.25" - 60"	SHV-J??-060	368.16	421.62
60.25" - 64"	SHV-J??-064	383.50	440.95
64.25" - 67"	SHV-J??-067	394.98	455.45
67.25" - 72"	SHV-J??-072	414.14	479.62
72.25" - 75"	SHV-J??-075	425.64	494.11
75.25" - 79"	SHV-J??-079	440.95	513.47
79.25" - 87"	SHV-J??-087	471.61	552.14
87.25" - 96"	SHV-J??-096	506.09	595.65
96.25" - 108"	SHV-J??-108	552.06	653.65
108.25" - 120"	SHV-J??-120	598.04	711.65
120.25" - 144"	SHV-J??-144	689.97	827.65

Standard Widths:
9.25", 12" and
14.5" widths

Premium Widths:
16.5" and 18" widths

Lengths: Minimum: 33"
Maximum: 144".
Order any length from
33" to 144" in
1/4" increments.

Style Note:
J1-3-Equal Size Panels,
J2-Smaller Centre Panel
(2/5, 1/5, 2/5),
J3-Smaller Top Panel
(1/5, 2/5, 2/5)

**All shutter prices
are per pair.**

CAT: SHVB	L - SPACED BOARD & BATTEN	PRICE	
		STANDARD	PREMIUM
18.00" - 36"	SHV-L??-036	152.37	237.19
36.25" - 39"	SHV-L??-039	157.89	246.32
39.25" - 43"	SHV-L??-043	165.17	258.54
43.25" - 48"	SHV-L??-048	174.85	272.66
48.25" - 52"	SHV-L??-052	182.93	285.46
52.25" - 55"	SHV-L??-055	209.72	332.74
55.25" - 60"	SHV-L??-060	218.85	347.95
60.25" - 64"	SHV-L??-064	226.19	360.13
64.25" - 67"	SHV-L??-067	231.65	369.26
67.25" - 72"	SHV-L??-072	240.78	384.52
72.25" - 75"	SHV-L??-075	246.27	393.65
75.25" - 79"	SHV-L??-079	253.58	405.83
79.25" - 87"	SHV-L??-087	268.20	430.18
87.25" - 96"	SHV-L??-096	284.64	457.62
96.25" - 108"	SHV-L??-108	306.57	494.16
108.25" - 120"	SHV-L??-120	328.49	530.71
120.25" - 144"	SHV-L??-144	372.37	603.83

Standard Widths:
7.75" and 12" widths

Premium Widths:
16.25" and 20.5" widths

Lengths: Minimum: 18"
Maximum: 144".
Order any length from
18" to 144" in
1/4" increments.

Style Note:
7.750" Width 2-Boards
12.00" Width 3-Boards
16.25" Width 4-Boards
20.50" Width 5-Boards

**All shutter prices
are per pair.**

CAT: SHVB	M - JOINED BOARD & BATTEN	PRICE		
		STANDARD	PREMIUM	M2-ARCHED TOP
18.00" - 36"	SHV-M??-036	152.37	237.19	N/A
36.25" - 39"	SHV-M??-039	157.89	246.32	N/A
39.25" - 43"	SHV-M??-043	165.17	258.54	N/A
43.25" - 48"	SHV-M??-048	174.85	272.66	409.00
48.25" - 52"	SHV-M??-052	182.93	285.46	428.19
52.25" - 55"	SHV-M??-055	209.72	332.74	499.10
55.25" - 60"	SHV-M??-060	218.85	347.95	521.93
60.25" - 64"	SHV-M??-064	226.19	360.13	540.19
64.25" - 67"	SHV-M??-067	231.65	369.26	553.88
67.25" - 72"	SHV-M??-072	240.78	384.52	576.79
72.25" - 75"	SHV-M??-075	246.27	393.65	590.48
75.25" - 79"	SHV-M??-079	253.58	405.83	608.74
79.25" - 87"	SHV-M??-087	268.20	430.18	645.26
87.25" - 96"	SHV-M??-096	284.64	457.62	686.43
96.25" - 108"	SHV-M??-108	306.57	494.16	N/A
108.25" - 120"	SHV-M??-120	328.49	530.71	N/A
120.25" - 144"	SHV-M??-144	372.37	603.83	N/A

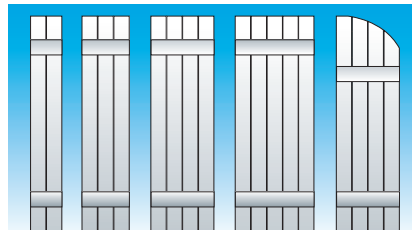

- M BOARD & BATTEN JOINED BOARDS**
- AVAILABLE IN
2, 3, 4 AND 5 SLATS
(Depending on size requirements)

Standard Widths:
7" and 10.5" widths. M2 Arched Top available in 14" only

Premium Widths:
14" and 17.5" widths

Lengths: Minimum: 18", Maximum: 144". Order any length from 18" to 144" in 1/4" increments.
M2 Arched Top - Minimum: 45", Maximum: 94"

Style Note:
7.00" Width 2-Boards; 10.50" Width 3-Boards; 14.00" Width 4-Boards; 17.50" Width 5-Boards

All shutter prices are per pair.



PAINT SCH. CODE: 1A

Make the **ULTIMATE** First Impression in your neighbourhood!

www.valor.ca

VALOR SPECIALTY PRODUCTS INC.

1800 Courtneypark Dr. East, Units 2-4
Mississauga, ON Canada L5T 1W1

TEL: (905) 564-3122 • FAX: (905) 564-5470

Shutter Accessories



A **Quarter Round Tops**

- Typically used on round or arch top windows.
- Available only in 14.5" width and 17" height.
- Louvered and solid styles.
- Colours (see page 1).
- Not available for Board & Batten style

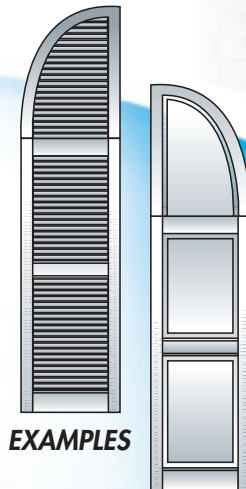

B **Shutter Lock Plastic Fastener**

- Eliminates the need for anchors if installed in masonry material.
- Available in all shutter colours. 12/bag.

C **Decorative Hinge & S-Hook**

- Replicate the look of old traditional hinged shutters with S-Hooks (or holdback)
- Includes 4 Hinges & 2 S-Hooks
- Available in black only. Hinge & S-Hooks are sold as a kit and cannot be purchased separately.

Quarter Round Tops

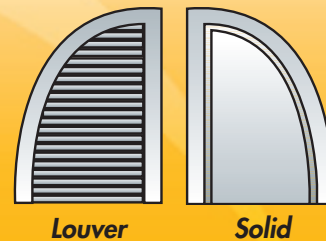

Shutter Lock Plastic Fastener

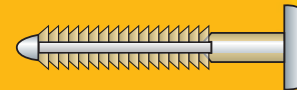

Decorative Hinge & S-Hook

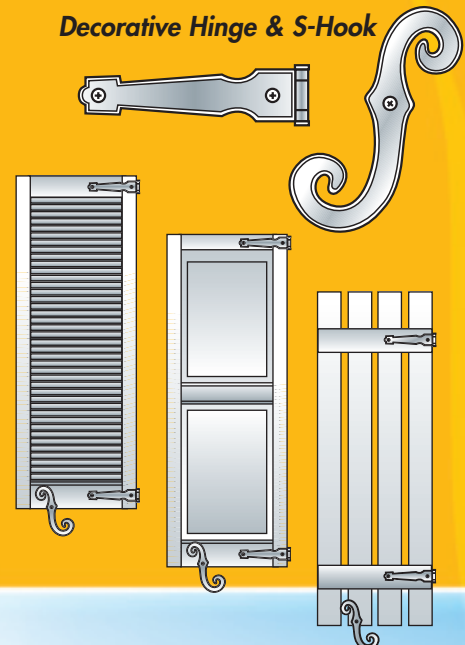

CAT: SHVX		SHUTTER ACCESSORIES
PRODUCT NO.	DESCRIPTION	PRICE*
SHX-1001517	QTR Round Top-Louver	68.85
SHX-2001517	QTR Round Top-Solid	68.85
SHX-300300	Shutter Lock Fastener	12.44
SHX-400300BK	Hinge & S-Hook	36.18

*Quarter round prices are per pair.



Make the ULTIMATE First Impression in your neighbourhood!

www.valor.ca

VALOR SPECIALTY PRODUCTS INC.

1800 Courtneypark Dr. East, Units 2-4
Mississauga, ON Canada L5T 1W1

TEL: (905) 564-3122 • FAX: (905) 564-5470



SPECIALTY PRODUCTS INC.

Fiberglass Pultruded Columns



CAT: MCF11		SQUARE COLUMNS	
PRODUCT NO.	DESCRIPTION	PACKAGING (per box)	PRICE* (each)
MCF-100107072	8 x 72in Square - Plain	1	151.24
MCF-100107096	8 x 96in Square - Plain	1	201.65
MCF-100107108	8 x 108in Square - Plain	1	226.85
MCF-100107120	8 x 120in Square - Plain	1	252.06
MCF-100107144	8 x 144in Square - Plain	1	302.47
MCF-100110072	10 x 72in Square - Plain	1	214.98
MCF-100110096	10 x 96in Square - Plain	1	286.64
MCF-100110108	10 x 108in Square - Plain	1	322.47
MCF-100110120	10 x 120in Square - Plain	1	358.30
MCF-100110144	10 x 144in Square - Plain	1	429.96

Actual Size: 8.0in = 7.25in / 10.0in = 9.372in

CAT: MCF12		RECESSED SQUARE COLUMNS	
PRODUCT NO.	DESCRIPTION	PACKAGING (per box)	PRICE* (each)
MCF-100207072	8 x 72in Square - Recessed	1	202.20
MCF-100207096	8 x 96in Square - Recessed	1	269.60
MCF-100207108	8 x 108in Square - Recessed	1	303.30
MCF-100207120	8 x 120in Square - Recessed	1	337.00
MCF-100207144	8 x 144in Square - Recessed	1	404.40
MCF-100210072	10 x 72in Square - Recessed	1	279.54
MCF-100210096	10 x 96in Square - Recessed	1	372.72
MCF-100210108	10 x 108in Square - Recessed	1	419.31
MCF-100210120	10 x 120in Square - Recessed	1	465.90
MCF-100210144	10 x 144in Square - Recessed	1	559.08

Actual Size: 8.0in = 7.25in / 10.0in = 9.372in

CAT: MCF20		ROUND STRAIGHT (NON-TAPERED) COLUMNS	
PRODUCT NO.	DESCRIPTION	PACKAGING (per box)	PRICE* (each)
MCF-200107072	8 x 72in Round - Plain	1	161.10
MCF-200107096	8 x 96in Round - Plain	1	214.80
MCF-200107108	8 x 108in Round - Plain	1	241.65
MCF-200107120	8 x 120in Round - Plain	1	268.50
MCF-200107144	8 x 144in Round - Plain	1	322.20
MCF-200110072	10 x 72in Round - Plain	1	244.50
MCF-200110096	10 x 96in Round - Plain	1	326.00
MCF-200110108	10 x 108in Round - Plain	1	366.75
MCF-200110120	10 x 120in Round - Plain	1	407.50
MCF-200110144	10 x 144in Round - Plain	1	489.00

Actual Size: 8in = 8in / 10.0in = 9.3in

*Prices above do not include Caps, Bases or Inserts. Specifications may change



Fiberglass columns must be painted
FOR PAINTING INSTRUCTIONS:
 visit www.valor.ca/resources.html



Make the **ULTIMATE** First Impression in your neighbourhood!

www.valor.ca

VALOR SPECIALTY PRODUCTS INC.

1800 Courtneypark Dr. East, Units 2-4
 Mississauga, ON Canada L5T 1W1

TEL: (905) 564-3122 • FAX: (905) 564-5470

Column Caps, Bases and Accessories

CAT: MCF11			
FOR 8in. SQUARE FIBERGLASS COLUMNS			
PRODUCT NO.	DESCRIPTION	PACKAGING (per box)	PRICE (each)
MCF-11010701	8in (PU) SQR Tuscan Cap	1	25.43
MCF-11020701	8in (PU) SQR Tuscan Base	1	32.11
CAT: MCA			
FOR 8in. SQUARE FIBERGLASS COLUMNS			
MCA-316070010	8in PVC SQR Low Prof. Trim	1	20.61
MCA-316070020	8in PVC SQR Crown Trim	1	30.22
MCA-316070030	8in PVC SQR Colonial Casing Trim	1	30.22
MCA-316070040	8in PVC SQR Colonial Box Trim	1	34.34
MCA-316070050	8in PVC SQR Tuscan Cap	1	25.43
MCA-316070060	8in PVC SQR Tuscan Base	1	32.11
MCA-316070070	8in PVC SQR Bead Base Cap	1	16.74
MCA-318070101	8in PVC SQR OGEE Trim Ring	1	22.32
MCA-320070101	8in x 5/8in PVC SQR Mounting Skirt	1	23.49
MCA-312070010	8in PVC SQR REC Cap Inserts	4	16.77
MCA-312070020	8in PVC SQR REC Base Inserts	4	22.84
MCA-312070030	8in PVC SQR REC Centre Inserts	4	16.77
MCA-3170700401	8in x 3.50in PVC SQR Box Cap/Base	1	18.32
MCA-3170700601	8in x 5.50in PVC SQR Box Cap/Base	1	26.43
MCA-3170700801	8in x 7.25in PVC SQR Box Cap/Base	1	33.51
MCA-3170701001	8in x 9.25in PVC SQR Box Cap/Base	1	41.64
MCA-3170701201	8in x 11.25in PVC SQR Box Cap/Base	1	49.74
MCF-3170700702	8in x 7.25in PVC SQR Box Cap/Base, w/Notch	1	40.22
MCF-3170701202	8in x 11.25in PVC SQR Box Cap/Base, w/Notch	1	59.69
	Custom SQR Box Cap/Base	Quote	Quote
MCA-3210700601	8in x 5.50in PVC SQR Classic Box Cap/Base	1	29.07
MCA-3210700801	8in x 7.25in PVC SQR Classic Box Cap/Base	1	36.86
MCA-3210701001	8in x 9.25in PVC SQR Classic Box Cap/Base	1	45.80
MCA-3210701201	8in x 11.25in PVC SQR Classic Box Cap/Base	1	54.71
MCA-3210701601	8in x 15.25in PVC SQR Classic Box Cap/Base	1	73.80

CAT: MCF11			
FOR 10in. SQUARE FIBERGLASS COLUMNS			
PRODUCT NO.	DESCRIPTION	PACKAGING (per box)	PRICE (each)
MCF-11011001	10in (PU) SQR Tuscan Cap	1	30.22
MCF-11021001	10in (PU) SQR Tuscan Base	1	33.37
CAT: MCA			
FOR 10in. SQUARE FIBERGLASS COLUMNS			
MCA-316100010	10in PVC SQR Low Prof. Trim	1	25.19
MCA-316100020	10in PVC SQR Crown Trim	1	37.09
MCA-316100030	10in PVC SQR Colonial Casing Trim	1	37.09
MCA-316100040	10in PVC SQR Colonial Box Trim	1	42.11
MCA-316100050	10in PVC SQR Tuscan Cap	1	30.22
MCA-316100060	10in PVC SQR Tuscan Base	1	33.37
MCA-316100070	10in PVC SQR Bead Base Cap	1	19.48
MCA-318100101	10in PVC SQR OGEE Trim Ring	1	29.25
MCA-320100101	10in x 5/8in PVC SQR Mounting Skirt	1	30.77
MCA-312100010	10in PVC SQR REC Cap Insert	4	19.94
MCA-312100020	10in PVC SQR REC Base Insert	4	27.53
MCA-312100030	10in PVC SQR REC Centre Insert	4	19.94
MCA-3171000401	10in x 3.50in PVC SQR Box Cap/Base	1	21.91
MCA-3171000601	10in x 5.50in PVC SQR Box Cap/Base	1	37.42
MCA-3171000801	10in x 7.25in PVC SQR Box Cap/Base	1	40.98
MCA-3171001001	10in x 9.25in PVC SQR Box Cap/Base	1	51.14
MCA-3171001201	10in x 11.25in PVC SQR Box Cap/Base	1	61.31
	Custom SQR Box Cap/Base	Quote	Quote
MCA-3211000601	10in x 5.50in PVC SQR Classic Box Cap/Base	1	41.16
MCA-3211000801	10in x 7.25in PVC SQR Classic Box Cap/Base	1	45.08
MCA-3211001001	10in x 9.25in PVC SQR Classic Box Cap/Base	1	56.25
MCA-3211001201	10in x 11.25in PVC SQR Classic Box Cap/Base	1	67.44
MCA-3211001601	10in x 15.25in PVC SQR Classic Box Cap/Base	1	89.80
CAT: MCF20			
FOR 8.0 & 10.0in. ROUND NON-TAPERED COLUMNS			
MCF-21010801	8in (PU) Round Tuscan Cap w/Trim Ring	1	30.22
MCF-21020801	8in (PU) Round Tuscan Base	1	33.37
MCA-318080201	8in PVC Round OGEE Trim Ring	1	22.32
MCF-21011001	10in (PU) Round Tuscan Cap w/Trim Ring	1	33.24
MCF-21021001	10in (PU) Round Tuscan Base	1	33.37
CAT: MCA			
MOUNTING HARDWARE			
MCA-912515004	Steel Bracket 1.25 x 1.50in Galv.	4 pack	1.86
MCA-912515100	Steel Bracket 1.25 x 1.50in Galv.	100 pack	46.64

* All Caps, Bases, and Trim Rings for Fiberglass Columns are shipped fully Assembled. Should you wish to received Split Product, please advise us at the time of placing your order.

See product images on next page.



Column Caps, Bases and Accessories

Polyurethane (PU) Tuscan SQR Cap



Polyurethane (PU) 8in Tuscan Round Cap



Polyurethane (PU) 10in Tuscan Round Cap

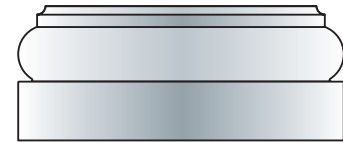

Polyurethane (PU) Tuscan SQR Base



Polyurethane (PU) 7.25in Tuscan Round Base



Polyurethane (PU) 9.5in Tuscan Round Base



Base Cap Trim Ring

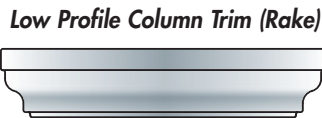

Low Profile Column Trim (Rake)

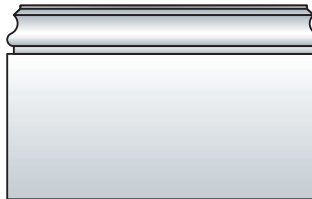

PVC SQR Classic Box Cap/Base
Standard Heights:
5.5, 7.25, 9.25, 11.25 & 15.25in.

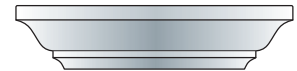

Crown Cap



Low Profile Column Trim (Rake)



OGEE Trim Ring



Colonial Casing Trim (RB3)

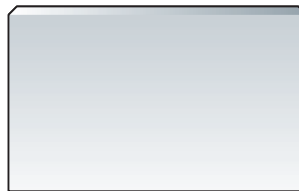

PVC SQR Box Cap/Base
Standard Heights:
3.5, 5.5, 7.25, 9.25, 11.25in.



PVC Mounting Skirt



Colonial Box Trim (Back Band)



Steel Bracket (Galv.)

Fiberglass Round Tapered Columns



CAT: MCF21		ROUND TAPERED SMOOTH COLUMNS (CAST)	
PRODUCT NO.	DESCRIPTION	PACKAGING (per box)	PRICE (each)
MCF-200208060	8.0 x 60in Round Tapered	1	337.32
MCF-200208072	8.0 x 72in Round Tapered	1	367.88
MCF-200208096	8.0 x 96in Round Tapered	1	410.68
MCF-200208108	8.0 x 108in Round Tapered	1	457.15
MCF-200208120	8.0 x 120in Round Tapered	1	506.24
MCF-200210096	10.0 x 96in Round Tapered	1	490.73
MCF-200210108	10.0 x 108in Round Tapered	1	557.89
MCF-200210120	10.0 x 120in Round Tapered	1	619.87
MCF-200210144	10.0 x 144in Round Tapered	1	878.17
MCF-200212096	12.0 x 96in Round Tapered	1	684.44
MCF-200212108	12.0 x 108in Round Tapered	1	775.25
MCF-200212120	12.0 x 120in Round Tapered	1	885.72
MCF-200212144	12.0 x 144in Round Tapered	1	1199.15
MCF-200308001	8.0in Tuscan Cap/Base Kit	1	95.83
MCF-200310001	10.0in Tuscan Cap/Base Kit	1	137.15
MCF-200312001	12.0in Tuscan Cap/Base Kit	1	183.89

Other Tapered Column sizes available upon request.
Fluted Column sizes available upon request.



PAINT SCH. CODE: 2B



Fiberglass columns must be painted
FOR PAINTING INSTRUCTIONS:
visit www.valor.ca/resources.html



Make the ULTIMATE First Impression in your neighbourhood!

www.valor.ca

VALOR SPECIALTY PRODUCTS INC.

1800 Courtneypark Dr. East, Units 2-4
Mississauga, ON Canada L5T 1W1

TEL: (905) 564-3122 • FAX: (905) 564-5470

PVC Trim Boards

CAT: VTB	TRIM BOARDS - REGULAR DENSITY (RD)		
PRODUCT NO.	DESCRIPTION	PACKAGING	PRICE (each)
VTB-405004144	1/2 x 3.5x144in PVC Trimboard - RD (SM/SM)	1	23.18
VTB-405006144	1/2 x 5.5x144in PVC Trimboard - RD (SM/SM)	1	36.28
VTB-405008144	1/2 x 7.25x144in PVC Trimboard - RD (SM/SM)	1	45.60
VTB-405010144	1/2 x 9.25x144in PVC Trimboard - RD (SM/SM)	1	56.24
VTB-405012144	1/2 x 11.25x144in PVC Trimboard - RD (SM/SM)	1	66.89
VTB-406304144	5/8 x 3.5x144in PVC Trimboard - RD (SM/SM)	1	30.43
VTB-406306144	5/8 x 5.5x144in PVC Trimboard - RD (SM/SM)	1	43.81
VTB-406308144	5/8 x 7.25x144in PVC Trimboard - RD (SM/SM)	1	55.53
VTB-406310144	5/8 x 9.25x144in PVC Trimboard - RD (SM/SM)	1	68.91
VTB-406312144	5/8 x 11.25x144in PVC Trimboard - RD (SM/SM)	1	82.70
VTB-407504144	3/4 x 3.5x144in PVC Trimboard - RD (SM/WG)	1	30.99
VTB-407506144	3/4 x 5.5x144in PVC Trimboard - RD (SM/WG)	1	50.37
VTB-407508144	3/4 x 7.25x144in PVC Trimboard - RD (SM/WG)	1	67.16
VTB-407510144	3/4 x 9.25x144in PVC Trimboard - RD (SM/WG)	1	80.58
VTB-407512144	3/4 x 11.25x144in PVC Trimboard - RD (SM/WG)	1	100.74
VTB-410004144	1 x 3.5x144in PVC Trimboard - RD (SM/SM)	1	40.63
VTB-410006144	1 x 5.5x144in PVC Trimboard - RD (SM/SM)	1	67.02
VTB-410008144	1 x 7.25x144in PVC Trimboard - RD (SM/SM)	1	88.09
VTB-410010144	1 x 9.25x144in PVC Trimboard - RD (SM/SM)	1	105.70
VTB-410012144	1 x 11.25x144in PVC Trimboard - RD (SM/SM)	1	132.09

NEW - Trim Board Multi-Packs

Available for all trim board items. Call our office for details and pricing.

CAT: VTB	TRIM BOARDS - HEAVY DENSITY (HD)		
PRODUCT NO.	DESCRIPTION	PACKAGING	PRICE (each)
VTB-07504144	3/4 x 3.50 x 144in PVC Trimboard - HD (SM/WG)	1	33.04
VTB-07505144	3/4 x 4.50 x 144in PVC Trimboard - HD (SM/WG)	1	Quote
VTB-07506144	3/4 x 5.50 x 144in PVC Trimboard - HD (SM/WG)	1	51.84
VTB-07508144	3/4 x 7.25 x 144in PVC Trimboard - HD (SM/WG)	1	68.25
VTB-07510144	3/4 x 9.25 x 144in PVC Trimboard - HD (SM/WG)	1	86.56
VTB-07512144	3/4 x 11.25 x 144in PVC Trimboard - HD (SM/WG)	1	105.59
VTB-10004144	1 x 3.50 x 144in PVC Trimboard - HD (SM/WG)	1	43.35
VTB-10006144	1 x 5.50 x 144in PVC Trimboard - HD (SM/WG)	1	68.13
VTB-10008144	1 x 7.25 x 144in PVC Trimboard - HD (SM/WG)	1	89.94
VTB-10010144	1 x 9.25 x 144in PVC Trimboard - HD (SM/WG)	1	114.75
VTB-10012144	1 x 11.25 x 144in PVC Trimboard - HD (SM/WG)	1	139.57
VTB-2107504144	3/4 x 3.50 x 144in PVC Trimboard - HD (BNS/SM)	1	37.36
VTB-2107506144	3/4 x 5.50 x 144in PVC Trimboard - HD (BNS/SM)	1	56.16
VTB-2107508144	3/4 x 7.25 x 144in PVC Trimboard - HD (BNS/SM)	1	72.57
VTB-2107510144	3/4 x 9.25 x 144in PVC Trimboard - HD (BNS/SM)	1	90.88
VTB-2107512144	3/4 x 11.25 x 144in PVC Trimboard - HD (BNS/SM)	1	109.91
VTB-2110004144	1 x 3.50 x 144in PVC Trimboard - HD (BNS/SM)	1	47.67
VTB-2110006144	1 x 5.50 x 144in PVC Trimboard - HD (BNS/SM)	1	72.45
VTB-2110008144	1 x 7.25 x 144in PVC Trimboard - HD (BNS/SM)	1	94.26
VTB-2110010144	1 x 9.25 x 144in PVC Trimboard - HD (BNS/SM)	1	119.07
VTB-2110012144	1 x 11.25 x 144in PVC Trimboard - HD (BNS/SM)	1	143.89

Call for many more product options not listed in this catalogue.

SM - Smooth / WG - Wood Grain / BNS - Bullnose



PAINT SCH. CODE: 1B

PVC Trimboard
Smooth (SM) &
Wood Grain (WG)

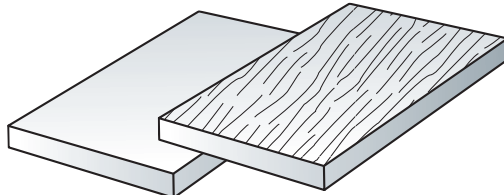

PVC Trimboard Smooth
with Bullnose (BNS)

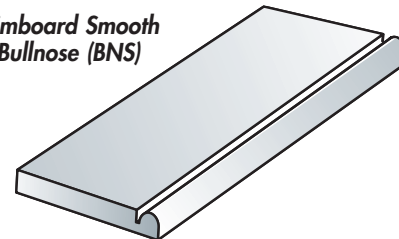

Make the ULTIMATE First Impression in your neighbourhood!

www.valor.ca

VALOR SPECIALTY PRODUCTS INC.

1800 Courtneypark Dr. East, Units 2-4
Mississauga, ON Canada L5T 1W1

TEL: (905) 564-3122 • FAX: (905) 564-5470

PVC Sheet Goods

CAT: VFS	SHEET GOODS - REGULAR DENSITY (RD)		
PRODUCT NO.	DESCRIPTION	PACKAGING	PRICE (each)
VFS-54809610	3/8 x 48 x 96in. PVC Sheet - RD (SM/SM)	1 Sheet	133.95
VFS-54814410	3/8 x 48 x 144in. PVC Sheet - RD (SM/SM)	1 Sheet	200.93
VFS-54809612	1/2 x 48 x 96in. PVC Sheet - RD (SM/SM)	1 Sheet	170.35
VFS-54812012	1/2 x 48 x 120in. PVC Sheet - RD (SM/SM)	1 Sheet	212.94
VFS-54814412	1/2 x 48 x 144in. PVC Sheet - RD (SM/SM)	1 Sheet	255.53
VFS-54809616	5/8 x 48 x 96in. PVC Sheet - RD (SM/SM)	1 Sheet	222.77
VFS-54812016	5/8 x 48 x 120in. PVC Sheet - RD (SM/SM)	1 Sheet	278.46
VFS-54814416	5/8 x 48 x 144in. PVC Sheet - RD (SM/SM)	1 Sheet	334.15
VFS-54809619	3/4 x 48 x 96in. PVC Sheet - RD (SM/SM)	1 Sheet	247.52
VFS-54814419	3/4 x 48 x 144in. PVC Sheet - RD (SM/SM)	1 Sheet	371.28
VFS-54809625	1 x 48 x 96in. PVC Sheet - RD (SM/SM)	1 Sheet	333.42
VFS-54814425	1 x 48 x 144in. PVC Sheet - RD (SM/SM)	1 Sheet	500.14
CAT: VFS	SHEET GOODS - HEAVY DENSITY (HD)		
PRODUCT NO.	DESCRIPTION	PACKAGING	PRICE (each)
VFS-14809610	3/8 x 48 x 96in PVC Sheet - HD (SM/SM)	1 Sheet	142.93
VFS-14809612	1/2 x 48 x 96in PVC Sheet - HD (SM/SM)	1 Sheet	181.82
VFS-14809616	5/8 x 48 x 96in PVC Sheet - HD (SM/SM)	1 Sheet	228.69
VFS-14812016	5/8 x 48 x 120in PVC Sheet - HD (SM/SM)	1 Sheet	300.15
VFS-14814416	5/8 x 48 x 144in PVC Sheet - HD (SM/SM)	1 Sheet	360.18
VFS-14809619	3/4 x 48 x 96in PVC Sheet - HD (SM/SM)	1 Sheet	271.56
VFS-14809625	1 x 48 x 96in PVC Sheet - HD (SM/SM)	1 Sheet	358.51

SM - Smooth / WG - Wood Grain

CAT: VFS	HANDI-PANELS		
PRODUCT NO.	DESCRIPTION	PACKAGING	PRICE (each)
VFS-32404810	3/8 x 24 x 48in PVC Panel (SM/SM)	1 Sheet	43.30
VFS-33204810	3/8 x 32 x 48in PVC Panel (SM/SM)	1 Sheet	57.73
VFS-34804810	3/8 x 48 x 48in PVC Panel (SM/SM)	1 Sheet	86.59
VFS-31209610	3/8 x 12 x 96in PVC Panel (SM/SM)	1 Sheet	43.30
VFS-31609610	3/8 x 16 x 96in PVC Panel (SM/SM)	1 Sheet	57.73
VFS-32409610	3/8 x 24 x 96in PVC Panel (SM/SM)	1 Sheet	86.59
VFS-32404812	1/2 x 24 x 48in PVC Panel (SM/SM)	1 Sheet	50.02
VFS-33204812	1/2 x 32 x 48in PVC Panel (SM/SM)	1 Sheet	66.69
VFS-34804812	1/2 x 48 x 48in PVC Panel (SM/SM)	1 Sheet	100.03
VFS-31209612	1/2 x 12 x 96in PVC Panel (SM/SM)	1 Sheet	50.02
VFS-31609612	1/2 x 16 x 96in PVC Panel (SM/SM)	1 Sheet	66.69
VFS-32409612	1/2 x 24 x 96in PVC Panel (SM/SM)	1 Sheet	100.03
CAT: VFS	BEAD BOARD-MILLED		
PRODUCT NO.	DESCRIPTION	PACKAGING	PRICE (each)
VBB-10506192	1/2 x 5-1/2 x 192in Bead Board (Milled)	1 Sheet	68.69
VBS-10504896	1/2 x 48 x 96in Beaded Sheet (Milled)	1 Sheet	274.75
CAT: VFS	PVC TRIM & SHEET-ACCESSORIES		
PRODUCT NO.	DESCRIPTION	PACKAGING	PRICE (each)
FAS-10108X20001	2in Cortex Screw & Plastic Cap - White (SM)	1 Box (400pcs)	109.20
FAS-10108X27501	2-3/4in Cortex Screw & Plastic Cap - White (SM)	1 Box (400pcs)	109.20
FAS-10208X20001	2in Cortex Screw & Plastic Cap - White (WG)	1 Box (400pcs)	109.20
FAS-10208X20001	2-3/4in Cortex Screw & Plastic Cap - White (WG)	1 Box (400pcs)	109.20
MLX-20010008	3M 500FC PU Adhesive White - 300ml Cart	1	19.99



PAINT SCH. CODE: 1B

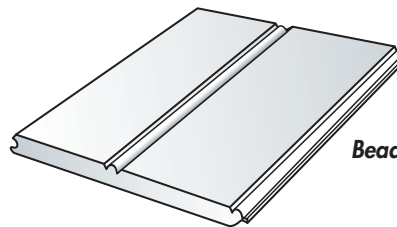
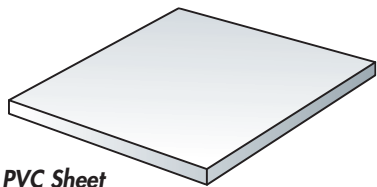

Polyurethane Adhesive Sealant

Make the **ULTIMATE** First Impression in your neighbourhood!

www.valor.ca

VALOR SPECIALTY PRODUCTS INC.

1800 Courtneypark Dr. East, Units 2-4
Mississauga, ON Canada L5T 1W1

TEL: (905) 564-3122 • FAX: (905) 564-5470

PVC J-Pocket Trim & Skirtboards



CAT: MCT		J-POCKET TRIM & SKIRTBOARDS	
PRODUCT NO.	DESCRIPTION	PACKAGING	PRICE (each)
MCT-2110004096	1.00 x 3.50 x 96.0in PVC J-Pocket Casing (SM)	1	35.55
MCT-2110006096	1.00 x 5.50 x 96.0in PVC J-Pocket Casing (SM)	1	58.65
MCT-2110008096	1.00 x 7.25 x 96.0in PVC J-Pocket Casing (SM)	1	77.08
MCT-2110004144	1.00 x 3.50 x 144.0in PVC J-Pocket Casing (SM)	1	53.33
MCT-2110006144	1.00 x 5.50 x 144.0in PVC J-Pocket Casing (SM)	1	87.98
MCT-2110008144	1.00 x 7.25 x 144.0in PVC J-Pocket Casing (SM)	1	115.62
MCT-2210004096	1.00 x 3.50 x 96.0in PVC J-Pocket Casing (WG)	1	35.55
MCT-2210006096	1.00 x 5.50 x 96.0in PVC J-Pocket Casing (WG)	1	58.65
MCT-2210008096	1.00 x 7.25 x 96.0in PVC J-Pocket Casing (WG)	1	77.08
MCT-2210004144	1.00 x 3.50 x 144.0in PVC J-Pocket Casing (WG)	1	53.33
MCT-2210006144	1.00 x 5.50 x 144.0in PVC J-Pocket Casing (WG)	1	87.98
MCT-2210008144	1.00 x 7.25 x 144.0in PVC J-Pocket Casing (WG)	1	115.62
MCT-5107504144	0.75 x 3.50 x 144in PVC Skirtboard (SM)	1	38.74
MCT-5107506144	0.75 x 5.50 x 144in PVC Skirtboard (SM)	1	62.96
MCT-5107508144	0.75 x 7.25 x 144in PVC Skirtboard (SM)	1	83.95
MCT-5110004144	1.00 x 3.50 x 144in PVC Skirtboard (SM)	1	50.79
MCT-5110006144	1.00 x 5.50 x 144in PVC Skirtboard (SM)	1	83.90
MCT-5110008144	1.00 x 7.25 x 144in PVC Skirtboard (SM)	1	110.11
MCT-5207504144	0.75 x 3.50 x 144in PVC Skirtboard (WG)	1	38.74
MCT-5207506144	0.75 x 5.50 x 144in PVC Skirtboard (WG)	1	62.96
MCT-5207508144	0.75 x 7.25 x 144in PVC Skirtboard (WG)	1	83.95
MCT-5210004144	1.00 x 3.50 x 144in PVC Skirtboard (WG)	1	50.79
MCT-5210006144	1.00 x 5.50 x 144in PVC Skirtboard (WG)	1	83.90
MCT-5210008144	1.00 x 7.25 x 144in PVC Skirtboard (WG)	1	110.11
MCT-1406303144	0.625 x 2.5 x 144in PVC T-Mould (SM)	1	50.79
CAT: MCT		SOFFIT PANELS	
MCT-5100516144	0.50 x 15.25 x 144.0in PVC Soffit Vented (Typ:01) (SM)	1	133.50
MCT-5100524144	0.50 x 23.25 x 144.0in PVC Soffit Vented (Typ:01) (SM)	1	202.50
CAT: MCT		NOTCHED FASCIA & FRIEZE	
MCT-6106306144	0.625 x 5.50 x 144.0in PVC Fascia Notched (SM)	1	58.95
MCT-6106308144	0.625 x 7.25 x 144.0in PVC Fascia Notched (SM)	1	72.00
MCT-6106310144	0.625 x 9.25 x 144.0in PVC Fascia Notched (SM)	1	90.50
MCT-6107506144	0.75 x 5.50 x 144.0in PVC Fascia Notched (SM)	1	63.50
MCT-6107508144	0.75 x 7.25 x 144.0in PVC Fascia Notched (SM)	1	78.00
MCT-6107510144	0.75 x 9.25 x 144.0in PVC Fascia Notched (SM)	1	94.65
MCT-7106306144	0.625 x 5.50 x 144.0in PVC Frieze Notched (SM)	1	73.00
MCT-7106308144	0.625 x 7.25 x 144.0in PVC Frieze Notched (SM)	1	86.00
MCT-7106310144	0.625 x 9.25 x 144.0in PVC Frieze Notched (SM)	1	104.60
MCT-7107506144	0.75 x 5.50 x 144.0in PVC Frieze Notched (SM)	1	77.65
MCT-7107508144	0.75 x 7.25 x 144.0in PVC Frieze Notched (SM)	1	92.30
MCT-7107510144	0.75 x 9.25 x 144.0in PVC Frieze Notched (SM)	1	109.00

SM - Smooth / WG - Wood Grain

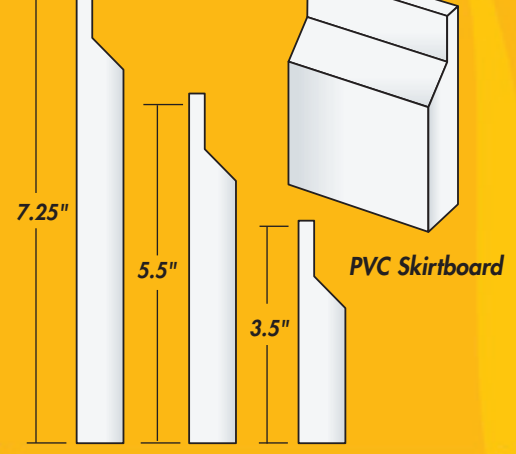
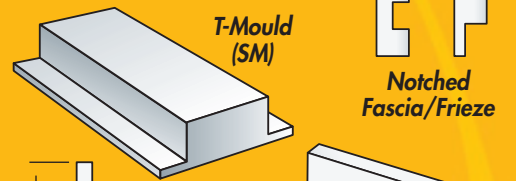
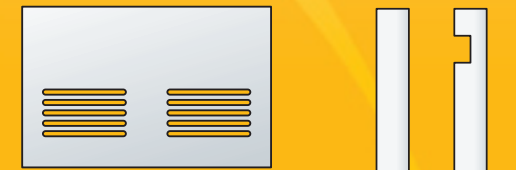
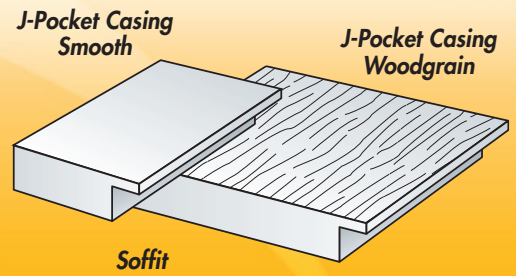

Make the **ULTIMATE** First Impression in your neighbourhood!

www.valor.ca

VALOR SPECIALTY PRODUCTS INC.

1800 Courtneypark Dr. East, Units 2-4
Mississauga, ON Canada L5T 1W1

TEL: (905) 564-3122 • FAX: (905) 564-5470

PVC Trims, Corners, Etc.



CAT: MMD	PREF-FABRICATED OUTSIDE CORNERS (MILLWORK)		
PRODUCT NO.	DESCRIPTION	PACKAGING	PRICE (each)
MCT-1107504096	3/4in - 3.50 x 96.0in O/S Corner (SM)	1	52.86
MCT-1107506096	3/4in - 5.50 x 96.0in O/S Corner (SM)	1	82.94
MCT-1107504120	3/4in - 3.50 x 120.0in O/S Corner (SM)	1	66.00
MCT-1107506120	3/4in - 5.50 x 120.0in O/S Corner (SM)	1	103.20
MCT-1207504096	3/4in - 3.50 x 96.0in O/S Corner (WG)	1	52.86
MCT-1207506096	3/4in - 5.50 x 96.0in O/S Corner (WG)	1	82.94
MCT-1207504120	3/4in - 3.50 x 120.0in O/S Corner (WG)	1	66.00
MCT-1207506120	3/4in - 5.50 x 120.0in O/S Corner (WG)	1	103.20
MCT-1110004096	1.0in - 3.50 x 96.0in O/S Corner (SM)	1	69.37
MCT-1110006096	1.0in - 5.50 x 96.0in O/S Corner (SM)	1	108.43
MCT-1110004120	1.0in - 3.50 x 120.0in O/S Corner (SM)	1	86.40
MCT-1110006120	1.0in - 5.50 x 120.0in O/S Corner (SM)	1	135.60
MCT-1210004096	1.0in - 3.50 x 96.0in O/S Corner (WG)	1	69.37
MCT-1210006096	1.0in - 5.50 x 96.0in O/S Corner (WG)	1	108.43
MCT-1210004120	1.0in - 3.50 x 120.0in O/S Corner (WG)	1	86.40
MCT-1210006120	1.0in - 5.50 x 120.0in O/S Corner (WG)	1	135.60
MCT-1307504096	3/4in - 3.50 x 96.0in O/S Corner BNS (SM)	1	59.53
MCT-1307506096	3/4in - 5.50 x 96.0in O/S Corner BNS (SM)	1	89.61
MCT-1307508096	3/4in - 7.25 x 96.0in O/S Corner BNS (SM)	1	115.87
MCT-1307504120	3/4in - 3.50 x 120.0in O/S Corner BNS (SM)	1	74.40
MCT-1307506120	3/4in - 5.50 x 120.0in O/S Corner BNS (SM)	1	111.60
MCT-1307508120	3/4in - 7.25 x 120.0in O/S Corner BNS (SM)	1	145.20
MCT-1310004096	1.0in - 3.50 x 96.0in O/S Corner BNS (SM)	1	82.54
MCT-1310006096	1.0in - 5.50 x 96.0in O/S Corner BNS (SM)	1	122.59
MCT-1310008096	1.0in - 7.25 x 96.0in O/S Corner BNS (SM)	1	157.48
MCT-1310004120	1.0in - 3.50 x 120.0in O/S Corner BNS (SM)	1	103.20
MCT-1310006120	1.0in - 5.50 x 120.0in O/S Corner BNS (SM)	1	153.60
MCT-1310008120	1.0in - 7.25 x 120.0in O/S Corner BNS (SM)	1	196.80
MCT-1510004096	1.0in - 3.50 x 96.0in O/S J-Corner (SM)	1	78.78
MCT-1510006096	1.0in - 5.50 x 96.0in O/S J-Corner (SM)	1	124.69
MCT-1510004120	1.0in - 3.50 x 120.0in O/S J-Corner (SM)	1	99.60
MCT-1510006120	1.0in - 5.50 x 120.0in O/S J-Corner (SM)	1	156.00
MCT-1610004096	1.0in - 3.50 x 96.0in O/S J-Corner (WG)	1	78.78
MCT-1610006096	1.0in - 5.50 x 96.0in O/S J-Corner (WG)	1	124.69
MCT-1610004120	1.0in - 3.50 x 120.0in O/S J-Corner (WG)	1	99.60
MCT-1610006120	1.0in - 5.50 x 120.0in O/S J-Corner (WG)	1	156.00

SM - Smooth / WG - Wood Grain / BNS - Bullnose

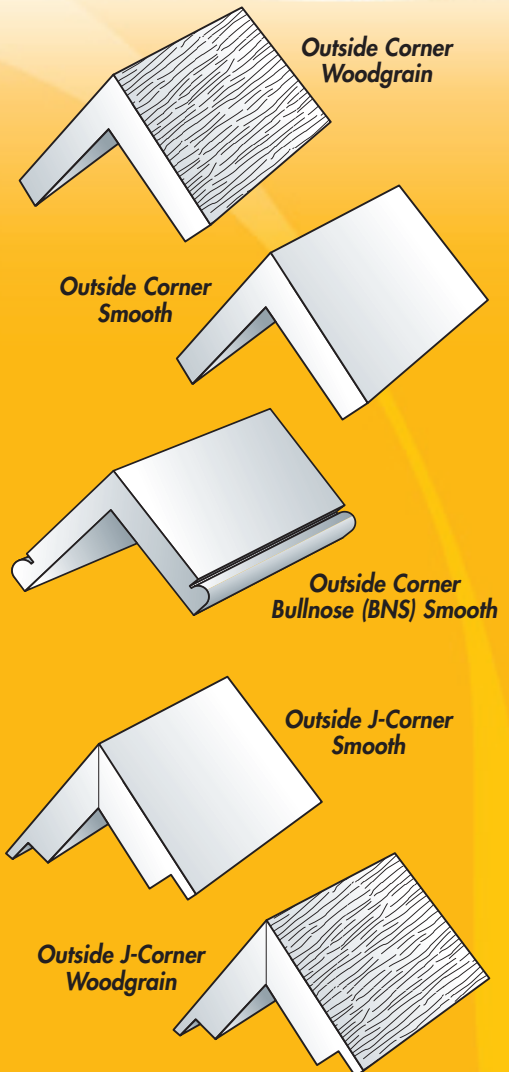

PAINT SCH. CODE: 1B

Make the ULTIMATE First Impression in your neighbourhood!

www.valor.ca

VALOR SPECIALTY PRODUCTS INC.

1800 Courtneypark Dr. East, Units 2-4
Mississauga, ON Canada L5T 1W1

TEL: (905) 564-3122 • FAX: (905) 564-5470

PVC Extruded Mouldings



PAINT SCH. CODE: 1C

CAT: VFP	PVC EXTRUDED MOULDINGS				
PRODUCT NO.	DESCRIPTION	DIMENSIONS	PACKAGING (per box)	LENGTH (ft)	PRICE (each)
VFP-10045144	5-1/4in Crown (#45)	9/16 x 5-1/4 x 144in	7	12	60.72
VFP-10045192	5-1/4in Crown (#45)	9/16 x 5-1/4 x 192in	7	16	81.00
VFP-10047144	4-5/8in Crown (#47)	11/16 x 4-5/8 x 144in	6	12	57.82
VFP-10047192	4-5/8in Crown (#47)	11/16 x 4-5/8 x 192in	6	16	70.02
VFP-12049144	3-5/8in Crown Scant (#49)	9/16 x 3-5/8 x 144in	10	12	35.04
VFP-12049192	3-5/8in Crown Scant (#49)	9/16 x 3-5/8 x 192in	10	16	46.79
VFP-12052144	2-3/4in Crown Scant (#52)	9/16 x 2-3/4 x 144in	14	12	31.80
VFP-12052192	2-3/4in Crown Scant (#52)	9/16 x 2-3/4 x 192in	14	16	42.36
VFP-13050144	5-1/4in Crown Cove (#500)	9/16 x 5-1/4 x 144in	7	12	56.76
VFP-13050192	5-1/4in Crown Cove (#500)	9/16 x 5-1/4 x 192in	7	16	75.70
VFP-14075144	Bed Moulding (#75)	9/16 x 1-5/8 x 144in	24	12	19.92
VFP-14075192	Bed Moulding (#75)	9/16 x 1-5/8 x 192in	24	16	26.62
VFP-15105144	3/4in Quarter Round (#107)	3/4 x 3/4 x 144in	38	12	15.36
VFP-15105192	3/4in Quarter Round (#107)	3/4 x 3/4 x 192in	38	16	20.49
VFP-15282144	3/4in Cove	3/4 x 3/4 x 144in	50	12	12.79
VFP-15282192	3/4in Cove	3/4 x 3/4 x 192in	50	16	17.12
VFP-16164144	Base Cap (#164)	11/16 x 1-1/8 x 144in	32	12	14.16
VFP-16164192	Base Cap (#164)	11/16 x 1-1/8 x 192in	32	16	18.82
VFP-17197144	Drip Cap (#197)	11/16 x 1-5/8 x 144in	22	12	21.60
VFP-17197192	Drip Cap (#197)	11/16 x 1-5/8 x 192in	22	16	28.83
VFP-18210144	Shingle Moulding (#210)	11/16 x 1-5/8 x 144in	18	12	21.60
VFP-18210192	Shingle Moulding (#210)	11/16 x 1-5/8 x 192in	18	16	28.83
VFP-19287144	Rake Moulding (#287)	1-1/16 x 2 x 144in	10	12	37.44
VFP-19287192	Rake Moulding (#287)	1-1/16 x 2 x 192in	10	16	49.84
VFP-20356144	Casing (#356)	11/16 x 2-1/4 x 144in	16	12	33.84
VFP-20356192	Casing (#356)	11/16 x 2-1/4 x 192in	16	16	45.10
VFP-20623144	Base Board (#623)	9/16 x 3-1/4 x 144in	10	12	30.36
VFP-20623192	Base Board (#623)	9/16 x 3-1/4 x 192in	10	16	40.50
VFP-21000144	Rams Crown	1-13/16 x 2 x 144in	8	12	53.88
VFP-21000192	Rams Crown	1-13/16 x 2 x 192in	8	16	71.88
VFP-22000144	RB3 Casing	1-7/64 x 3-7/16 x 144in	8	12	47.88
VFP-22000192	RB3 Casing	1-7/64 x 3-7/16 x 192in	8	16	63.91
VFP-23000144	1 x 4in Backband	1-3/16 x 4-1/2 x 144in	4	12	61.92
VFP-23000192	1 x 4in Backband	1-3/16 x 4-1/2 x 192in	4	16	82.56
VFP-24000144	Adjustable BackBand	1-11/32 x 1-13/32 x 144in	10	12	32.76
VFP-24000192	Adjustable BackBand	1-11/32 x 1-13/32 x 192in	10	16	43.74
VFP-28000144	Beaded Ceiling Panel	3/8 x 5-1/2 x 144in	10	12	44.25
VFP-28000192	Beaded Ceiling Panel	3/8 x 5-1/2 x 192in	10	16	59.00
VFP-29000144	BeadBoard	1/2 x 5-1/4 x 144in	9	12	52.68
VFP-29000192	BeadBoard	1/2 x 5-1/4 x 192in	9	16	70.17

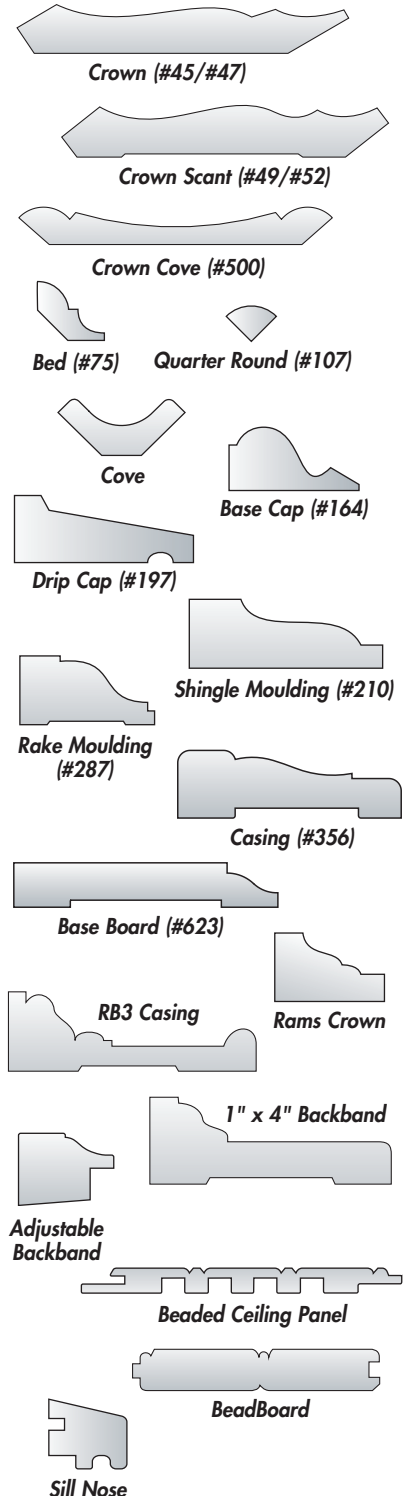

Make the ULTIMATE First Impression in your neighbourhood!

www.valor.ca

VALOR SPECIALTY PRODUCTS INC.

1800 Courtneypark Dr. East, Units 2-4
Mississauga, ON Canada L5T 1W1

TEL: (905) 564-3122 • FAX: (905) 564-5470

PVC Extruded Mouldings



PAINT SCH. CODE: 1C

CAT: VFP		PVC EXTRUDED MOULDINGS			
PRODUCT NO.	DESCRIPTION	DIMENSIONS	PACKAGING (per box)	LENGTH (ft)	PRICE (each)
VFP-30000144	Shingle Rake 3"	3/4 x 3.0 x 144in	1	12	42.96
VFP-30000192	Shingle Rake 3"	3/4 x 3.0 x 192in	1	16	57.20
VFP-31000120xx	Inside Cornerguard-10 ft	1-1/4 x 1-1/4 x 120in	9	10	32.70
VFP-32000120	Outside Cornerguard-10ft	3-1/2 x 3-1/2 x 120in	3	10	99.99
VFP-33000144	Sill Nose	1-3/8 x 1-5/8 x 144in	9	12	39.84
VFP-33000192	Sill Nose	1-3/8 x 1-5/8 x 192in	9	16	53.07
VFP-33024144	New England Sill	2-5/16 x 1-3/4 x 144in	6	12	55.15
VFP-33024192	New England Sill	2-5/16 x 1-3/4 x 192in	6	16	73.55
VFP-35150144	1.50x1.50 Baluster	1-1/2 x 1-1/2 x 144in	9	12	46.25
VFP-35150192	1.50x1.50 Baluster	1-1/2 x 1-1/2 x 192in	9	16	61.60
VFP-36000120	J-Channel Brickmould	1-1/4 x 3 x 120in	12	10	29.90
VFP-36000144	J-Channel Brickmould	1-1/4 x 3 x 144in	12	12	35.88
VFP-36000204	J-Channel Brickmould	1-1/4 x 3 x 204in	12	17	50.83
VFP-40180120	Brick Mould Flanged	1-1/4 x 3 x 120in	12	10	31.30
VFP-40180144	Brick Mould Flanged	1-1/4 x 3 x 144in	12	12	37.56
VFP-40180204	Brick Mould Flanged	1-1/4 x 3 x 204in	12	17	53.26
VFP-41180120	Brick Mould-Flat Back	1-1/4 x 2 x 120in	14	10	28.00
VFP-41180144	Brick Mould-Flat Back	1-1/4 x 2 x 144in	14	12	33.60
VFP-41180204	Brick Mould-Flat Back	1-1/4 x 2 x 204in	14	17	47.62

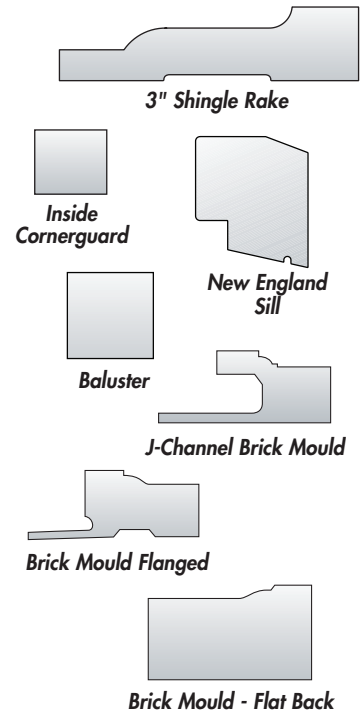

Make the ULTIMATE First Impression in your neighbourhood!

www.valor.ca

VALOR SPECIALTY PRODUCTS INC.

1800 Courtneypark Dr. East, Units 2-4
Mississauga, ON Canada L5T 1W1

TEL: (905) 564-3122 • FAX: (905) 564-5470

PVC Mounting Blocks



CAT: MSA	3/4IN (0.75IN) THICK BLOCKS		
PRODUCT NO.	DESCRIPTION	PACKAGING (per box)	PRICE (each)
MSA-101107501	PVC Block 0.75x6.5x6.5in w/3.5in CTR	10	5.07
MSA-102107501	PVC Block 0.75x8.0x8.0in w/3.5in CTR	10	7.68
MSA-103107501	PVC Block 0.75x8.0x12.0in w/Cut Outs	10	11.52
MSA-104107501	PVC Block 0.75x4.5x6.5in Receptacle Cut Out	10	4.68
MSA-104107502	PVC Block 0.75x4.5x6.5in w/1in CTR	10	4.68
MSA-104107503	PVC Block 0.75x4.5x6.5in w/1in CTR Split	10	4.68
MSA-105107501	PVC Block 0.75x4.5x6.5in Recess Cut Out	10	7.68
MSA-105107502	PVC Block 0.75x4.5x6.5in Recess Solid	10	7.68
CAT: MSA	3/4IN (0.75IN) THICK BLOCKS W/EXHAUST-INTAKE		
MSA-214107501	PVC Block 0.75x8.0x8.0in w/4in Hooded Exhaust	4	13.45
MSA-226107501	PVC Block 0.75x10.0x10.0in w/6in Hooded Exhaust	4	22.60
CAT: MSA	1-1/8IN (1.125IN) THICK BLOCKS		
MSA-101111301	PVC Block 1.125x6.5x6.5in w/3.5in CTR	10	8.37
MSA-102111301	PVC Block 1.125x8.0x8.0in w/3.5in CTR	10	12.67
MSA-103111301	PVC Block 1.125x8.0x12.0in w/3xCentres	10	19.00
MSA-104111301	PVC Block 1.125x4.5x6.5in Receptacle Cut Out	10	7.72
MSA-104111302	PVC Block 1.125x4.5x6.5in w/1in CTR	10	7.72
MSA-104111303	PVC Block 1.125x4.5x6.5in w/1in CTR Split	10	7.72
MSA-105111301	PVC Block 1.125x4.5x6.5in Recess Cut Out	10	12.67
MSA-105111302	PVC Block 1.125x4.5x6.5in Recess Solid	10	12.67
CAT: MSA	1-1/8IN (1.125IN) THICK BLOCKS W/EXHAUST-INTAKE		
MSA-214111301	PVC Block 1.125x8.0x8.0in w/4in Hooded Exhaust	10	22.19
MSA-226111301	PVC Block 1.125x10.0x10.0in w/6in Hooded Exhaust	10	37.29

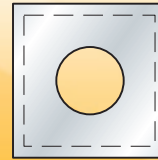

PVC Block
0.75x6.5x6.5in
w/3.5in CTR

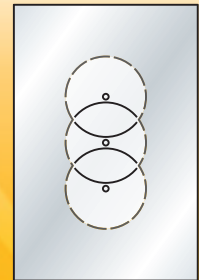

PVC Block
0.75x8.0x12.0in
w/cut outs

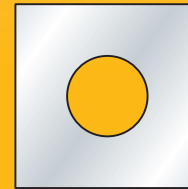

PVC Block
0.75x8.0x8.0in
w/3.5in CTR

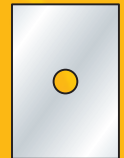

PVC Block
0.75x4.5x6.5in
w/1in CTR

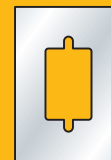

PVC Block
0.75x4.5x6.5in
Receptacle Cut Out

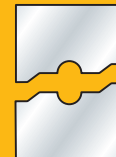

PVC Block
0.75x4.5x6.5in
w/1in CTR Split

PVC Block
0.75x4.5x6.5in
Recess Cut Out

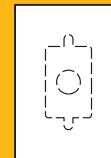

PVC Block
0.75x4.5x6.5in
Recess Solid

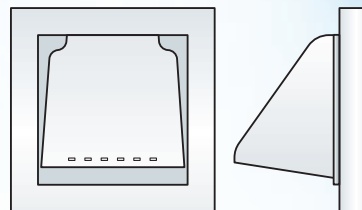

PVC Block Square
0.75x8x8in
w/4" Hooded Exhaust Vent

Make the ULTIMATE First Impression in your neighbourhood!

www.valor.ca

VALOR SPECIALTY PRODUCTS INC.

1800 Courtneypark Dr. East, Units 2-4
Mississauga, ON Canada L5T 1W1

TEL: (905) 564-3122 • FAX: (905) 564-5470



SPECIALTY PRODUCTS INC.

PVC Custom Shutters

...made to order

PVC CLOSED LOUVER SHUTTER

1.00x2.5in Frame, 5/8in Lvr Panel

CAT: MSH		PVC CLOSED LOUVER SHUTTER					
LENGTH	PRODUCT CODE	WIDTH					
		12.00IN	14.00IN	16.00IN	18.00IN	20.00IN	24.00IN
		PRICE					
up to 36"	MSH-110_036	192.54	208.82	225.10	241.39	265.81	290.24
up to 39"	MSH-110_039	201.10	218.54	235.98	253.43	279.59	305.75
up to 43"	MSH-110_043	212.52	231.50	250.49	269.48	297.95	326.43
up to 48"	MSH-110_048	226.79	247.71	268.62	289.54	320.91	352.29
up to 52"	MSH-110_052	238.21	260.67	283.13	305.59	339.28	372.97
up to 55"	MSH-110_055	246.78	270.39	294.01	317.63	353.05	388.48
up to 60"	MSH-110_060	261.05	286.60	312.14	337.69	376.01	414.33
up to 64"	MSH-110_064	272.47	299.56	326.65	353.74	394.38	435.01
up to 67"	MSH-110_067	281.03	309.28	337.53	365.78	408.15	450.53
up to 72"	MSH-110_072	295.31	325.49	355.66	385.84	431.11	476.38
up to 75"	MSH-110_075	303.87	335.21	366.54	397.88	444.89	491.89
up to 79"	MSH-110_079	315.29	348.17	381.05	413.93	463.25	512.57
up to 87"	MSH-110_087	338.13	374.10	410.07	446.03	499.99	553.94
up to 96"	MSH-110_096	363.82	403.26	442.71	482.15	541.31	600.47
up to 108"	MSH-110_108	398.08	442.15	486.23	530.30	596.41	662.52
up to 120"	MSH-110_120	432.34	481.04	529.75	578.45	651.51	724.57
up to 144"	MSH-110_144	500.85	558.82	616.79	674.76	761.71	848.66
ADD Arch Top Option:		42.40	42.40	42.40	42.40	42.40	42.40

Replace " " in Product code with desired width code. 12in-12 / All PVC shutter prices are per pair.

PVC PLUNGE ROUTED PANEL SHUTTERS

3/4in PVC

CAT: MSH		PVC PLUNGE ROUTED PANEL SHUTTERS					
LENGTH	PRODUCT CODE	WIDTH					
		12.00IN	14.00IN	16.00IN	18.00IN	20.00IN	24.00IN
		PRICE					
up to 36"	MSH-130_036	145.33	157.50	169.66	181.83	193.99	218.32
up to 39"	MSH-130_039	151.42	164.59	177.77	190.95	204.13	230.49
up to 43"	MSH-130_043	159.52	174.05	188.58	203.11	217.64	246.70
up to 48"	MSH-130_048	169.66	185.88	202.10	218.32	234.54	266.98
up to 52"	MSH-130_052	177.77	195.34	212.91	230.49	248.06	283.20
up to 55"	MSH-130_055	183.85	202.44	221.02	239.61	258.19	295.36
up to 60"	MSH-130_060	193.99	214.27	234.54	254.81	275.09	315.64
up to 64"	MSH-130_064	202.10	223.73	245.35	266.98	288.61	331.86
up to 67"	MSH-130_067	208.18	230.82	253.46	276.10	298.74	344.02
up to 72"	MSH-130_072	218.32	242.65	266.98	291.31	315.64	364.30
up to 75"	MSH-130_075	224.40	249.75	275.09	300.43	325.78	376.46
up to 79"	MSH-130_079	232.51	259.21	285.90	312.60	339.29	392.68
up to 87"	MSH-130_087	248.73	278.13	307.53	336.93	366.32	425.12
up to 96"	MSH-130_096	266.98	299.42	331.86	364.30	396.74	461.61
up to 108"	MSH-130_108	291.31	327.80	364.30	400.79	437.28	510.27
up to 120"	MSH-130_120	315.64	356.19	396.74	437.28	477.83	558.93
up to 144"	MSH-130_144	364.30	412.96	461.61	510.27	558.93	656.25
ADD Arch Top Option:		42.40	42.40	42.40	42.40	42.40	42.40

Replace " " in Product code with desired width code. 12in-12 / All PVC shutter prices are per pair.

PVC RECESSED PANEL SHUTTERS

1x2.5in; 3/8in Panel

CAT: MSH		PVC RECESSED PANEL SHUTTERS					
LENGTH	PRODUCT CODE	WIDTH					
		12.00IN	14.00IN	16.00IN	18.00IN	20.00IN	24.00IN
		PRICE					
up to 36"	MSH-120_036	168.46	178.90	189.34	199.78	210.22	231.10
up to 39"	MSH-120_039	174.92	186.01	197.09	208.18	219.26	241.43
up to 43"	MSH-120_043	183.54	195.48	207.43	219.37	231.32	255.21
up to 48"	MSH-120_048	194.31	207.33	220.35	233.37	246.39	272.43
up to 52"	MSH-120_052	202.92	216.81	230.69	244.57	258.45	286.21
up to 55"	MSH-120_055	209.39	223.91	238.44	252.97	267.49	296.54
up to 60"	MSH-120_060	220.16	235.76	251.36	266.96	282.56	313.77
up to 64"	MSH-120_064	228.77	245.24	261.70	278.16	294.62	327.54
up to 67"	MSH-120_067	235.24	252.34	269.45	286.56	303.66	337.88
up to 72"	MSH-120_072	246.01	264.19	282.37	300.55	318.73	355.10
up to 75"	MSH-120_075	252.47	271.30	290.12	308.95	327.78	365.43
up to 79"	MSH-120_079	261.09	280.77	300.46	320.15	339.83	379.21
up to 87"	MSH-120_087	278.32	299.73	321.13	342.54	363.95	406.76
up to 96"	MSH-120_096	297.71	321.05	344.39	367.74	391.08	437.76
up to 108"	MSH-120_108	323.56	349.48	375.40	401.33	427.25	479.10
up to 120"	MSH-120_120	349.41	377.91	406.41	434.92	463.42	520.43
up to 144"	MSH-120_144	401.11	434.77	468.44	502.10	535.76	603.09
ADD Arch Top Option:		42.40	42.40	42.40	42.40	42.40	42.40

Replace " " in Product code with desired width code. 12in-12 / All PVC shutter prices are per pair.

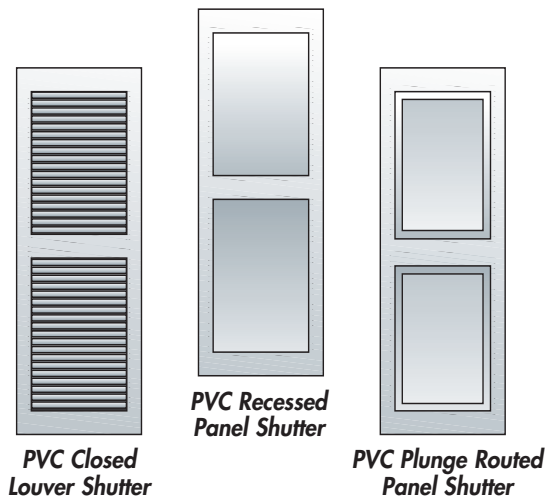

Make the **ULTIMATE** First Impression in your neighbourhood!

www.valor.ca

VALOR SPECIALTY PRODUCTS INC.

1800 Courtneypark Dr. East, Units 2-4
Mississauga, ON Canada L5T 1W1

TEL: (905) 564-3122 • FAX: (905) 564-5470



SPECIALTY PRODUCTS INC.

PVC Custom Shutters

...made to order

PVC BOARD & BATTEN SHUTTERS - 3.50IN BOARDS

3/4x3.5in Boards, 3/4in Batten

CAT: MSH		PVC BOARD & BATTEN SHUTTERS					
LENGTH	PRODUCT CODE	BATTEN	WIDTH				
			10.50IN	14.00IN	17.50IN	21.00IN	24.50IN
PRICE							
up to 36"	MSH-140_036	2 - BATTENS	156.68	191.39	226.11	260.83	295.54
up to 39"	MSH-140_039		164.25	201.50	238.74	275.98	313.22
up to 43"	MSH-140_043		174.36	214.96	255.57	296.18	336.78
up to 48"	MSH-140_048		186.98	231.80	276.61	321.43	366.24
up to 52"	MSH-140_052		197.08	245.26	293.45	341.63	389.81
up to 55"	MSH-140_055	3 - BATTENS	204.66	255.36	306.07	356.78	407.49
up to 60"	MSH-140_060		217.28	272.20	327.11	382.03	436.95
up to 64"	MSH-140_064		227.38	285.67	343.95	402.23	460.51
up to 67"	MSH-140_067		234.96	295.77	356.57	417.38	478.19
up to 72"	MSH-140_072		247.58	312.60	377.62	442.63	507.65
up to 75"	MSH-140_075		255.16	322.70	390.24	457.78	525.33
up to 79"	MSH-140_079		265.26	336.17	407.08	477.98	548.89
up to 87"	MSH-140_087		285.46	363.10	440.74	518.39	596.03
up to 96"	MSH-140_096		308.19	393.40	478.62	563.84	649.06
up to 108"	MSH-140_108		338.49	433.81	529.12	624.44	719.76
up to 120"	MSH-140_120	368.79	474.21	579.63	685.04	790.46	
up to 144"	MSH-140_144	429.39	555.01	680.63	806.25	931.87	
ADD Arch Top Option:		42.40	42.40	42.40	42.40	42.40	42.40

Replace " " in Product code with desired width code. 10.50in-11 / All PVC shutter prices are per pair.

PVC BOARD & BATTEN SHUTTERS W/DIAGONAL BATTEN

3/4x3.50in Boards, 3/4in Batten

CAT: MSH		PVC BOARD & BATTEN SHUTTERS					
LENGTH	PRODUCT CODE	BATTEN	WIDTH				
			10.50IN	14.00IN	17.50IN	21.00IN	24.50IN
PRICE							
up to 36"	MSH-142_036	2-BATTENS & 1-DIAGONAL BATTEN	192.87	229.25	265.91	302.79	339.82
up to 39"	MSH-142_039		202.68	241.41	280.42	319.66	359.08
up to 43"	MSH-142_043		215.86	257.76	299.95	342.36	384.96
up to 48"	MSH-142_048		232.43	278.37	324.56	370.97	417.58
up to 52"	MSH-142_052		245.75	294.94	344.36	394.00	443.83
up to 55"	MSH-142_055		255.76	307.40	359.26	411.34	463.60
up to 60"	MSH-142_060		272.48	328.22	384.18	440.33	496.65
up to 64"	MSH-142_064		285.87	344.91	404.16	463.58	523.18
up to 67"	MSH-142_067		295.92	357.45	419.16	481.05	543.11
up to 72"	MSH-142_072		312.70	378.37	444.21	510.22	576.39
up to 75"	MSH-142_075		322.77	390.93	459.26	527.75	596.39
up to 79"	MSH-142_079		336.20	407.69	479.34	551.14	623.08
up to 87"	MSH-142_087		363.08	441.24	519.55	597.98	676.55
up to 96"	MSH-142_096		393.35	479.03	564.83	650.76	736.81
up to 108"	MSH-142_108	433.73	529.45	625.28	721.21	817.26	
up to 120"	MSH-142_120	474.13	579.90	685.77	791.74	897.80	
up to 144"	MSH-142_144	554.96	680.86	806.85	932.92	1059.06	
ADD Arch Top Option:		42.40	42.40	42.40	42.40	42.40	42.40

Replace " " in Product code with desired width code. 10.50in-11 / All PVC shutter prices are per pair.

PVC BOARD & BATTEN SHUTTERS - 4.00IN BOARDS

3/4x4.0in Boards, 3/4in Batten

CAT: MSH		PVC BOARD & BATTEN SHUTTERS					
LENGTH	PRODUCT CODE	BATTEN	WIDTH				
			12.00IN	16.00IN	20.00IN	24.00IN	28.00IN
PRICE							
up to 36"	MSH-140_036	2 - BATTENS	166.84	204.94	243.04	281.14	286.18
up to 39"	MSH-140_039		175.10	215.95	256.81	297.66	302.71
up to 43"	MSH-140_043		186.12	230.65	275.17	319.70	324.75
up to 48"	MSH-140_048		199.89	249.01	298.13	347.25	352.29
up to 52"	MSH-140_052		210.91	263.70	316.49	369.29	374.33
up to 55"	MSH-140_055	3 - BATTENS	219.17	274.72	330.27	385.81	390.86
up to 60"	MSH-140_060		232.95	293.08	353.22	413.36	418.40
up to 64"	MSH-140_064		243.97	307.78	371.59	435.40	440.44
up to 67"	MSH-140_067		252.23	318.80	385.36	451.93	456.97
up to 72"	MSH-140_072		266.00	337.16	408.32	479.47	484.52
up to 75"	MSH-140_075		274.27	348.18	422.09	496.00	501.04
up to 79"	MSH-140_079		285.29	362.87	440.45	518.04	523.08
up to 87"	MSH-140_087		307.32	392.25	477.18	562.11	567.16
up to 96"	MSH-140_096		332.12	425.31	518.50	611.70	616.74
up to 108"	MSH-140_108		365.17	469.38	573.60	677.81	682.85
up to 120"	MSH-140_120	398.23	513.46	628.69	743.92	748.96	
up to 144"	MSH-140_144	464.34	601.61	738.88	876.14	881.19	
ADD Arch Top Option:		42.40	42.40	42.40	42.40	42.40	

Replace " " in Product code with desired width code. 12.00in-12 / All PVC shutter prices are per pair.

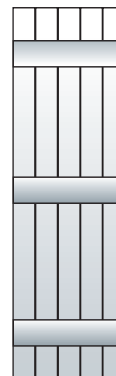

PVC Board & Batten Shutter



PVC Board & Batten Shutter w/Diagonal Batten



PAINT SCH. CODE: 1B

Make the **ULTIMATE** First Impression in your neighbourhood!

www.valor.ca

VALOR SPECIALTY PRODUCTS INC.

1800 Courtneypark Dr. East, Units 2-4
Mississauga, ON Canada L5T 1W1

TEL: (905) 564-3122 • FAX: (905) 564-5470



SPECIALTY PRODUCTS INC.

PVC Custom Shutters

...made to order

PVC BOARD & BATTEN SHUTTERS W/DIAGONAL BATTEN

3/4x4.00in Boards, 3/4in Batten

CAT: MSH		PVC BOARD & BATTEN SHUTTERS					
LENGTH	PRODUCT CODE	BATTEN	WIDTH				
			12.00IN	16.00IN	20.00IN	24.00IN	28.00IN
PRICE							
up to 36"	MSH-142_036	2-BATTENS & 1-DIAGONAL BATTEN	189.87	231.62	273.68	315.97	323.80
up to 39"	MSH-142_039		200.69	245.12	289.88	334.89	342.56
up to 43"	MSH-142_043		215.23	263.29	311.67	360.32	367.80
up to 48"	MSH-142_048		233.54	286.18	339.14	392.36	399.62
up to 52"	MSH-142_052		248.25	304.60	361.25	418.15	425.25
up to 55"	MSH-142_055		259.31	318.46	377.89	437.57	444.56
up to 60"	MSH-142_060		277.79	341.62	405.71	470.04	476.87
up to 64"	MSH-142_064		292.60	360.19	428.03	496.10	502.81
up to 67"	MSH-142_067		303.72	374.14	444.80	515.68	522.31
up to 72"	MSH-142_072		322.27	397.42	472.80	548.38	554.89
up to 75"	MSH-142_075		333.41	411.41	489.61	568.02	574.47
up to 79"	MSH-142_079		348.27	430.06	512.06	594.25	600.62
up to 87"	MSH-142_087		378.01	467.42	557.01	646.77	653.01
up to 96"	MSH-142_096		411.50	509.49	607.65	705.96	712.07
up to 108"	MSH-142_108		456.19	565.64	675.24	784.98	790.96
up to 120"	MSH-142_120		500.90	621.83	742.90	864.09	869.97
up to 144"	MSH-142_144		590.36	734.30	878.34	1022.49	1028.21
ADD Arch Top Option:		42.40	42.40	42.40	42.40	42.40	

Replace " " in Product code with desired width code. 12.00in-12 / All PVC shutter prices are per pair.

PVC PREMIUM RAISED GROOVED PANEL SHUTTERS

1in PVC

CAT: MSH		PVC PREMIUM RAISED GROOVED PANEL SHUTTERS					
LENGTH	PRODUCT CODE	WIDTH					
		12.00IN	14.00IN	16.00IN	18.00IN	20.00IN	24.00IN
PRICE							
up to 36"	MSH-160_036	183.65	210.71	226.94	248.58	270.23	313.51
up to 39"	MSH-160_039	194.48	223.78	241.37	264.82	288.26	335.16
up to 43"	MSH-160_043	208.90	241.22	260.61	286.46	312.31	364.01
up to 48"	MSH-160_048	226.94	263.01	284.65	313.51	342.37	400.08
up to 52"	MSH-160_052	241.37	280.45	303.89	335.16	366.42	428.94
up to 55"	MSH-160_055	252.19	293.52	318.32	351.39	384.45	450.59
up to 60"	MSH-160_060	270.23	315.32	342.37	378.44	414.51	486.66
up to 64"	MSH-160_064	284.65	332.75	361.61	400.08	438.56	515.51
up to 67"	MSH-160_067	295.48	345.83	376.04	416.32	456.60	537.16
up to 72"	MSH-160_072	313.51	367.62	400.08	443.37	486.66	573.23
up to 75"	MSH-160_075	324.33	380.70	414.51	459.60	504.69	594.87
up to 79"	MSH-160_079	338.76	398.13	433.75	481.25	528.74	623.73
up to 87"	MSH-160_087	367.62	433.00	472.23	524.53	576.84	681.44
up to 96"	MSH-160_096	400.08	472.23	515.51	573.23	630.94	746.37
up to 108"	MSH-160_108	443.37	524.53	573.23	638.16	703.09	832.95
up to 120"	MSH-160_120	486.66	576.84	630.94	703.09	775.23	919.52
up to 144"	MSH-160_144	573.23	681.44	746.37	832.95	919.52	1092.66
ADD Arch Top Option:		42.40	42.40	42.40	42.40	42.40	42.40

Replace " " in Product code with desired width code. 12.00in-12 / All PVC shutter prices are per pair.

PVC PREMIUM RAISED PANEL SHUTTERS

1in PVC

CAT: MSH		PVC PREMIUM RAISED PANEL SHUTTERS					
LENGTH	PRODUCT CODE	WIDTH					
		12.00IN	14.00IN	16.00IN	20.00IN	24.00IN	
PRICE							
up to 36"	MSH-150_036	195.17	224.63	242.30	265.86	289.43	336.55
up to 39"	MSH-150_039	206.95	238.86	258.01	283.53	309.06	360.11
up to 43"	MSH-150_043	222.66	257.84	278.95	307.10	335.24	391.53
up to 48"	MSH-150_048	242.30	281.57	305.13	336.55	367.97	430.80
up to 52"	MSH-150_052	258.01	300.55	326.08	360.11	394.15	462.22
up to 55"	MSH-150_055	269.79	314.79	341.79	377.79	413.79	485.78
up to 60"	MSH-150_060	289.43	338.51	367.97	407.24	446.51	525.06
up to 64"	MSH-150_064	305.13	357.50	388.91	430.80	472.69	556.47
up to 67"	MSH-150_067	316.92	371.73	404.62	448.48	492.33	580.04
up to 72"	MSH-150_072	336.55	395.46	430.80	477.93	525.06	619.31
up to 75"	MSH-150_075	348.33	409.69	446.51	495.60	544.69	642.87
up to 79"	MSH-150_079	364.04	428.68	467.46	519.16	570.87	674.29
up to 87"	MSH-150_087	395.46	466.64	509.35	566.29	623.23	737.12
up to 96"	MSH-150_096	430.80	509.35	556.47	619.31	682.14	807.81
up to 108"	MSH-150_108	477.93	566.29	619.31	690.00	760.69	902.06
up to 120"	MSH-150_120	525.06	623.23	682.14	760.69	839.23	996.32
up to 144"	MSH-150_144	619.31	737.12	807.81	902.06	996.32	1184.82
ADD Arch Top Option:		42.40	42.40	42.40	42.40	42.40	42.40

Replace " " in Product code with desired width code. 12.00in-12 / All PVC shutter prices are per pair.



PVC Board & Batten Shutter w/Diagonal Batten

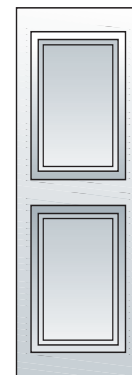

PVC Premium Raised Panel Shutter

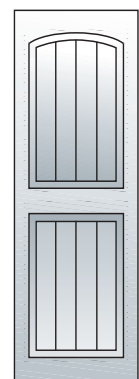

PVC Raised Grooved Panel Shutter



PAINT SCH. CODE: 1B

Make the **ULTIMATE** First Impression in your neighbourhood!

www.valor.ca

VALOR SPECIALTY PRODUCTS INC.

1800 Courtneypark Dr. East, Units 2-4
Mississauga, ON Canada L5T 1W1

TEL: (905) 564-3122 • FAX: (905) 564-5470

PVC Gable Accents

...made to order

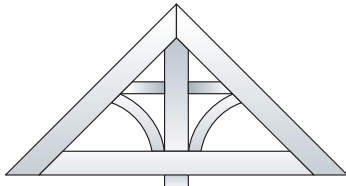

MGA-110 (Price Sch: 1B)

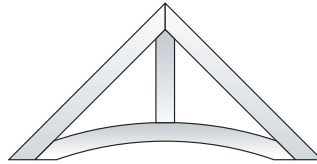

MGA-112 (Price Sch: 1B)

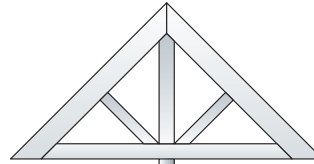

MGA-115 (Price Sch: 1F)

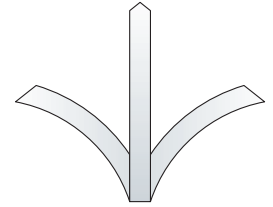

MGA-118 (Price Sch: 1E)

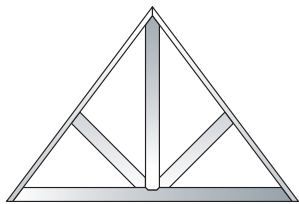

MGA-120 (Price Sch: 1G)

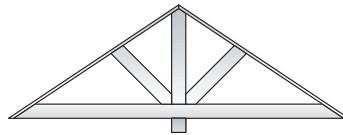

MGA-125 (Price Sch: 1D)

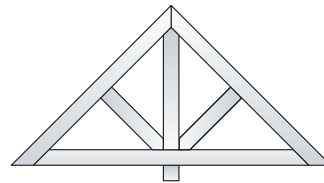

MGA-126 (Price Sch: 1F)

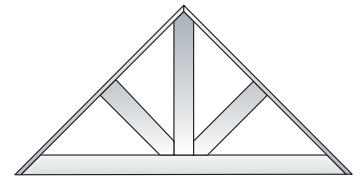

MGA-130 (Price Sch: 1D)

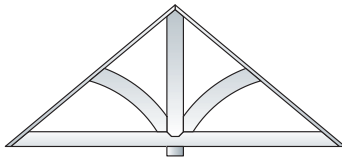

MGA-135 (Price Sch: 1D)

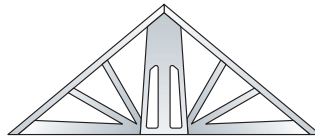

MGA-140 (Price Sch: 1C)

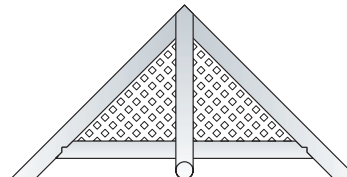

MGA-145 (Price Sch: 1A)

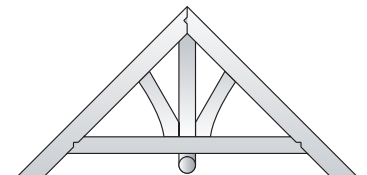

MGA-150 (Price Sch: 1C)

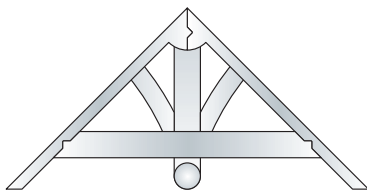

MGA-152 (Price Sch: 1C)

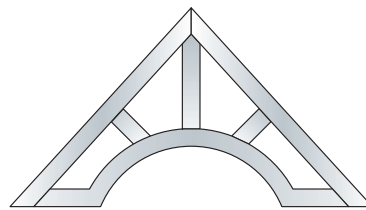

MGA-155 (Price Sch: 1C)

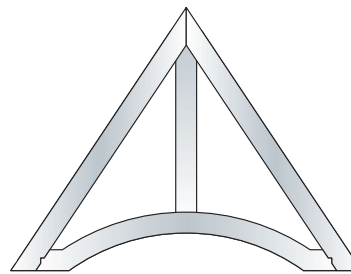

MGA-157 (Price Sch: 1C)

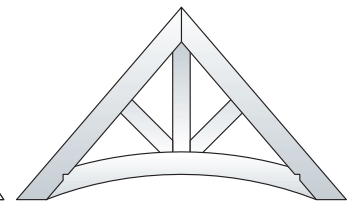

MGA-160 (Price Sch: 1A)

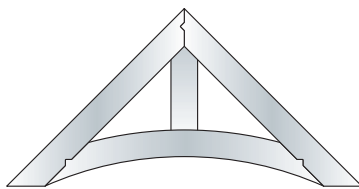

MGA-161 (Price Sch: 1C)

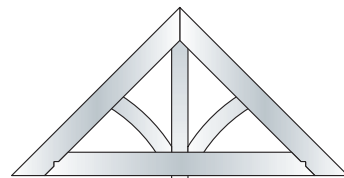

MGA-162 (Price Sch: 1C)

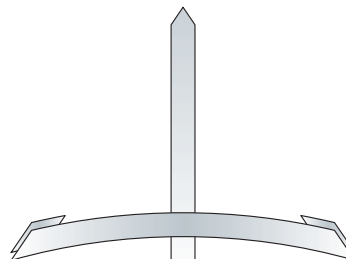

MGA-165 (Price Sch: 1E)

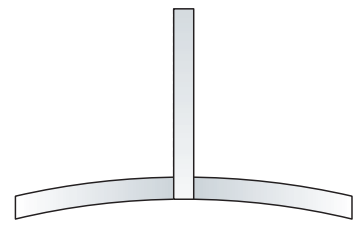

MGA-166 (Price Sch: 1E)

Make the ULTIMATE First Impression in your neighbourhood!

www.valor.ca

VALOR SPECIALTY PRODUCTS INC.

1800 Courtneypark Dr. East, Units 2-4
Mississauga, ON Canada L5T 1W1

TEL: (905) 564-3122 • FAX: (905) 564-5470

PVC Gable Accents

...made to order

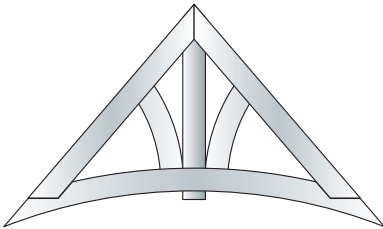

MGA-167 (Price Sch: 1A)

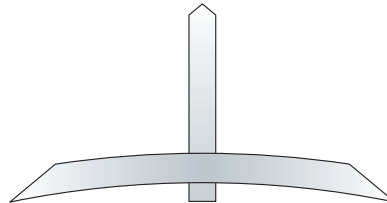

MGA-168 (Price Sch: 1E)

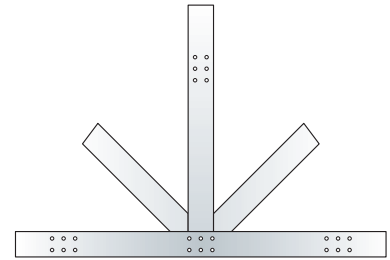

MGA-169 (Price Sch: 1F)

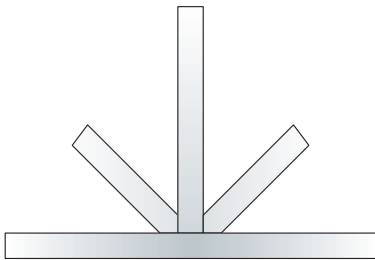

MGA-170 (Price Sch: 1F)

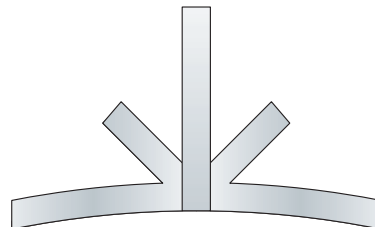

MGA-171 (Price Sch: 1C)

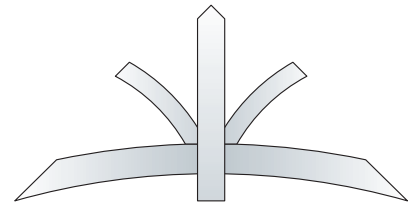

MGA-172 (Price Sch: 1B)

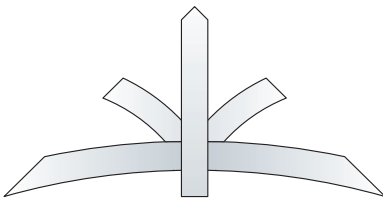

MGA-173 (Price Sch: 1C)

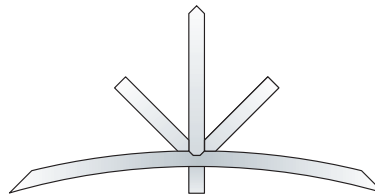

MGA-175 (Price Sch: 1G)

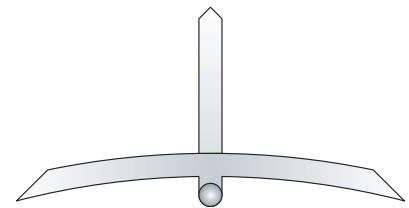

MGA-176 (Price Sch: 1G)

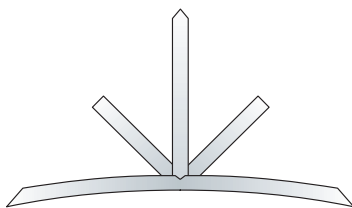

MGA-178 (Price Sch: 1D)

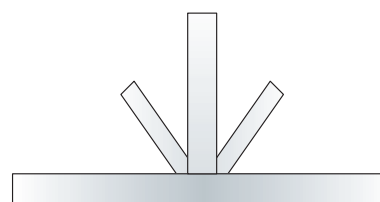

MGA-180 (Price Sch: 1D)

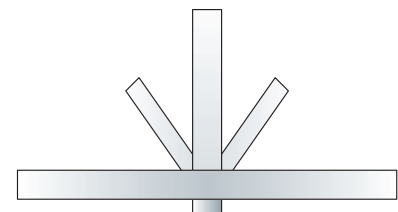

MGA-182 (Price Sch: 1D)

Make the ULTIMATE First Impression in your neighbourhood!

www.valor.ca

VALOR SPECIALTY PRODUCTS INC.

1800 Courtneypark Dr. East, Units 2-4
Mississauga, ON Canada L5T 1W1

TEL: (905) 564-3122 • FAX: (905) 564-5470

VALOR

SPECIALTY PRODUCTS INC.

PVC Gable Accents

...made to order

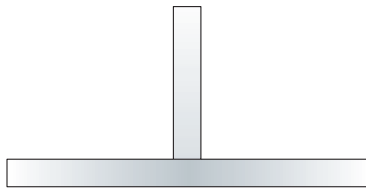

MGA-185 (Price Sch: 1E)

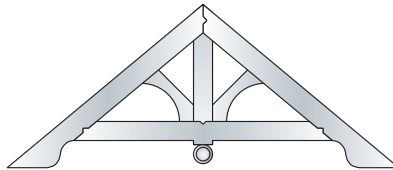

MGA-190 (Price Sch: 1A)

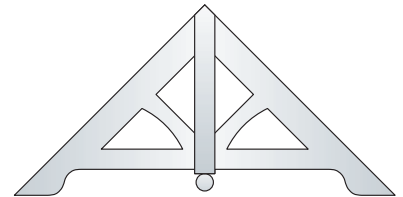

MGA-192 (Price Sch: 1B)

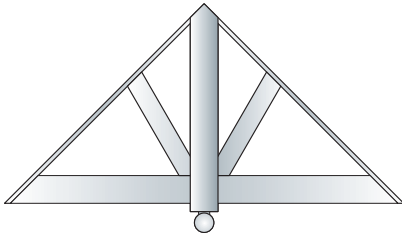

MGA-200 (Price Sch: 1H)

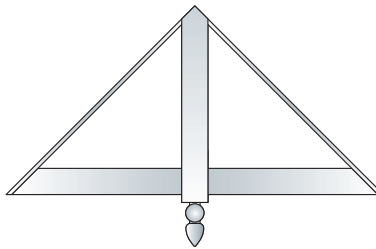

MGA-210 (Price Sch: 1H)

Make the ULTIMATE First Impression in your neighbourhood!

www.valor.ca

VALOR SPECIALTY PRODUCTS INC.

1800 Courtneypark Dr. East, Units 2-4
Mississauga, ON Canada L5T 1W1

TEL: (905) 564-3122 • FAX: (905) 564-5470



SPECIALTY PRODUCTS INC.

PVC Gable Accents

...made to order

CAT: MGA		GABLE ACCENTS - SCHEDULE: 1A															
BASE (IN.)	HEIGHT (IN.)	PITCH															
		5/12	6/12	7/12	8/12	9/12	10/12	11/12	12/12	13/12	14/12	15/12	16/12	17/12	18/12	19/12	20/12
36.00		7.50	9.00	10.50	12.00	13.50	15.00	16.50	18.00	19.50	21.00	22.50	24.00	25.50	27.00	28.50	30.00
PRICE:		195.93	200.41	204.88	209.35	213.82	218.29	222.77	227.24	231.71	236.18	240.65	245.13	249.60	254.07	258.54	263.01
42.00		8.75	10.50	12.25	14.00	15.75	17.50	19.25	21.00	22.75	24.50	26.25	28.00	29.75	31.50	33.25	35.00
PRICE:		217.55	222.77	227.98	233.20	238.42	243.63	248.85	254.07	259.29	264.50	269.72	274.94	280.15	285.37	290.59	295.81
48.00		10.00	12.00	14.00	16.00	18.00	20.00	22.00	24.00	26.00	28.00	30.00	32.00	34.00	36.00	38.00	40.00
PRICE:		239.16	245.13	251.09	257.05	263.01	268.98	274.94	280.90	286.86	292.83	298.79	304.75	310.71	316.68	322.64	328.60
54.00		11.25	13.50	15.75	18.00	20.25	22.50	24.75	27.00	29.25	31.50	33.75	36.00	38.25	40.50	42.75	45.00
PRICE:		260.78	267.48	274.19	280.90	287.61	294.32	301.02	307.73	314.44	321.15	327.85	334.56	341.27	347.98	354.69	361.39
60.00		12.50	15.00	17.50	20.00	22.50	25.00	27.50	30.00	32.50	35.00	37.50	40.00	42.50	45.00	47.50	50.00
PRICE:		282.39	289.84	297.30	304.75	312.20	319.66	327.11	334.56	342.02	349.47	356.92	364.38	371.83	379.28	386.73	394.19
66.00		13.75	16.50	19.25	22.00	24.75	27.50	30.25	33.00	35.75	38.50	41.25	44.00	46.75	49.50	52.25	55.00
PRICE:		304.00	312.20	320.40	328.60	336.80	345.00	353.20	361.39	369.59	377.79	385.99	394.19	402.39	410.58	418.78	426.98
72.00		15.00	18.00	21.00	24.00	27.00	30.00	33.00	36.00	39.00	42.00	45.00	48.00	51.00	54.00	57.00	60.00
PRICE:		325.62	334.56	343.51	352.45	361.39	370.34	379.28	388.23	397.17	406.11	415.06	424.00	432.94	441.89	450.83	459.78
78.00		16.25	19.50	22.75	26.00	29.25	32.50	35.75	39.00	42.25	45.50	48.75	52.00	55.25	58.50	61.75	65.00
PRICE:		347.23	356.92	366.61	376.30	385.99	395.68	405.37	415.06	424.75	434.43	444.12	453.81	463.50	473.19	482.88	492.57
84.00		17.50	21.00	24.50	28.00	31.50	35.00	38.50	42.00	45.50	49.00	52.50	56.00	59.50	63.00	66.50	70.00
PRICE:		368.85	379.28	389.72	400.15	410.58	421.02	431.45	441.89	452.32	462.75	473.19	483.63	494.06	504.49	514.93	525.36
90.00		18.75	22.50	26.25	30.00	33.75	37.50	41.25	45.00	48.75	52.50	56.25	60.00	63.75	67.50	71.25	75.00
PRICE:		390.46	401.64	412.82	424.00	435.18	446.36	457.54	468.72	479.90	491.08	502.26	513.44	524.62	535.80	546.98	558.16
96.00		20.00	24.00	28.00	32.00	36.00	40.00	44.00	48.00	52.00	56.00	60.00	64.00	68.00	72.00	76.00	80.00
PRICE:		412.08	424.00	435.93	447.85	459.78	471.70	483.63	495.55	507.48	519.40	531.33	543.25	555.18	567.10	579.03	590.95
102.00		21.25	25.50	29.75	34.00	38.25	42.50	46.75	51.00	55.25	59.50	63.75	68.00	72.25	76.50	80.75	85.00
PRICE:		433.69	446.36	459.03	471.70	484.37	497.04	509.71	522.38	535.05	547.72	560.39	573.06	585.73	598.40	611.07	623.74
108.00		22.50	27.00	31.50	36.00	40.50	45.00	49.50	54.00	58.50	63.00	67.50	72.00	76.50	81.00	85.50	90.00
PRICE:		455.30	468.72	482.13	495.55	508.97	522.38	535.80	549.21	562.63	576.04	589.46	602.88	616.29	629.71	643.12	656.54
114.00		23.75	28.50	33.25	38.00	42.75	47.50	52.25	57.00	61.75	66.50	71.25	76.00	80.75	85.50	90.25	95.00
PRICE:		476.92	491.08	505.24	519.40	533.56	547.72	561.88	576.04	590.20	604.37	618.53	632.69	646.85	661.01	675.17	689.33
120.00		25.00	30.00	35.00	40.00	45.00	50.00	55.00	60.00	65.00	70.00	75.00	80.00	85.00	90.00	95.00	100.00
PRICE:		498.53	513.44	528.34	543.25	558.16	573.06	587.97	602.88	617.78	632.69	647.59	662.50	677.41	692.31	707.22	722.13



Make the ULTIMATE First Impression in your neighbourhood!

www.valor.ca

VALOR SPECIALTY PRODUCTS INC.

1800 Courtneypark Dr. East, Units 2-4
Mississauga, ON Canada L5T 1W1

TEL: (905) 564-3122 • FAX: (905) 564-5470



SPECIALTY PRODUCTS INC.

PVC Gable Accents

...made to order

CAT: MGA		GABLE ACCENTS - SCHEDULE: 1B															
BASE (IN.)		PITCH															
		5/12	6/12	7/12	8/12	9/12	10/12	11/12	12/12	13/12	14/12	15/12	16/12	17/12	18/12	19/12	20/12
36.00		7.50	9.00	10.50	12.00	13.50	15.00	16.50	18.00	19.50	21.00	22.50	24.00	25.50	27.00	28.50	30.00
PRICE:		153.87	157.34	160.82	164.30	167.78	171.26	174.73	178.21	181.69	185.17	188.65	192.13	195.60	199.08	202.56	206.04
42.00		8.75	10.50	12.25	14.00	15.75	17.50	19.25	21.00	22.75	24.50	26.25	28.00	29.75	31.50	33.25	35.00
PRICE:		170.68	174.73	178.79	182.85	186.91	190.97	195.02	199.08	203.14	207.20	211.25	215.31	219.37	223.43	227.49	231.54
48.00		10.00	12.00	14.00	16.00	18.00	20.00	22.00	24.00	26.00	28.00	30.00	32.00	34.00	36.00	38.00	40.00
PRICE:		187.49	192.13	196.76	201.40	206.04	210.68	215.31	219.95	224.59	229.23	233.86	238.50	243.14	247.78	252.41	257.05
54.00		11.25	13.50	15.75	18.00	20.25	22.50	24.75	27.00	29.25	31.50	33.75	36.00	38.25	40.50	42.75	45.00
PRICE:		204.30	209.52	214.73	219.95	225.17	230.38	235.60	240.82	246.04	251.25	256.47	261.69	266.90	272.12	277.34	282.56
60.00		12.50	15.00	17.50	20.00	22.50	25.00	27.50	30.00	32.50	35.00	37.50	40.00	42.50	45.00	47.50	50.00
PRICE:		221.11	226.91	232.70	238.50	244.30	250.09	255.89	261.69	267.48	273.28	279.08	284.88	290.67	296.47	302.27	308.06
66.00		13.75	16.50	19.25	22.00	24.75	27.50	30.25	33.00	35.75	38.50	41.25	44.00	46.75	49.50	52.25	55.00
PRICE:		237.92	244.30	250.67	257.05	263.43	269.80	276.18	282.56	288.93	295.31	301.69	308.06	314.44	320.82	327.19	333.57
72.00		15.00	18.00	21.00	24.00	27.00	30.00	33.00	36.00	39.00	42.00	45.00	48.00	51.00	54.00	57.00	60.00
PRICE:		254.73	261.69	268.64	275.60	282.56	289.51	296.47	303.43	310.38	317.34	324.29	331.25	338.21	345.16	352.12	359.08
78.00		16.25	19.50	22.75	26.00	29.25	32.50	35.75	39.00	42.25	45.50	48.75	52.00	55.25	58.50	61.75	65.00
PRICE:		271.54	279.08	286.61	294.15	301.69	309.22	316.76	324.29	331.83	339.37	346.90	354.44	361.97	369.51	377.05	384.58
84.00		17.50	21.00	24.50	28.00	31.50	35.00	38.50	42.00	45.50	49.00	52.50	56.00	59.50	63.00	66.50	70.00
PRICE:		288.35	296.47	304.58	312.70	320.82	328.93	337.05	345.16	353.28	361.39	369.51	377.63	385.74	393.86	401.97	410.09
90.00		18.75	22.50	26.25	30.00	33.75	37.50	41.25	45.00	48.75	52.50	56.25	60.00	63.75	67.50	71.25	75.00
PRICE:		305.16	313.86	322.55	331.25	339.95	348.64	357.34	366.03	374.73	383.42	392.12	400.81	409.51	418.20	426.90	435.59
96.00		20.00	24.00	28.00	32.00	36.00	40.00	44.00	48.00	52.00	56.00	60.00	64.00	68.00	72.00	76.00	80.00
PRICE:		321.98	331.25	340.53	349.80	359.08	368.35	377.63	386.90	396.18	405.45	414.73	424.00	433.28	442.55	451.83	461.10
102.00		21.25	25.50	29.75	34.00	38.25	42.50	46.75	51.00	55.25	59.50	63.75	68.00	72.25	76.50	80.75	85.00
PRICE:		338.79	348.64	358.50	368.35	378.20	388.06	397.91	407.77	417.62	427.48	437.33	447.19	457.04	466.90	476.75	486.61
108.00		22.50	27.00	31.50	36.00	40.50	45.00	49.50	54.00	58.50	63.00	67.50	72.00	76.50	81.00	85.50	90.00
PRICE:		355.60	366.03	376.47	386.90	397.33	407.77	418.20	428.64	439.07	449.51	459.94	470.38	480.81	491.24	501.68	512.11
114.00		23.75	28.50	33.25	38.00	42.75	47.50	52.25	57.00	61.75	66.50	71.25	76.00	80.75	85.50	90.25	95.00
PRICE:		372.41	383.42	394.44	405.45	416.46	427.48	438.49	449.51	460.52	471.53	482.55	493.56	504.58	515.59	526.60	537.62
120.00		25.00	30.00	35.00	40.00	45.00	50.00	55.00	60.00	65.00	70.00	75.00	80.00	85.00	90.00	95.00	100.00
PRICE:		389.22	400.81	412.41	424.00	435.59	447.19	458.78	470.38	481.97	493.56	505.16	516.75	528.34	539.94	551.53	563.13



PAINT SCH. CODE: CALL

Make the ULTIMATE First Impression in your neighbourhood!

www.valor.ca

VALOR SPECIALTY PRODUCTS INC.

1800 Courtneypark Dr. East, Units 2-4
Mississauga, ON Canada L5T 1W1

TEL: (905) 564-3122 • FAX: (905) 564-5470

PVC Gable Accents

...made to order

CAT: MGA		GABLE ACCENTS - SCHEDULE: 1C															
BASE (IN.)	HEIGHT (IN.)	PITCH															
		5/12	6/12	7/12	8/12	9/12	10/12	11/12	12/12	13/12	14/12	15/12	16/12	17/12	18/12	19/12	20/12
36.00		7.50	9.00	10.50	12.00	13.50	15.00	16.50	18.00	19.50	21.00	22.50	24.00	25.50	27.00	28.50	30.00
PRICE:		167.12	170.59	174.07	177.55	181.03	184.51	187.98	191.46	194.94	198.42	201.90	205.38	208.85	212.33	215.81	219.29
42.00		8.75	10.50	12.25	14.00	15.75	17.50	19.25	21.00	22.75	24.50	26.25	28.00	29.75	31.50	33.25	35.00
PRICE:		183.93	187.98	192.04	196.10	200.16	204.22	208.27	212.33	216.39	220.45	224.50	228.56	232.62	236.68	240.74	244.79
48.00		10.00	12.00	14.00	16.00	18.00	20.00	22.00	24.00	26.00	28.00	30.00	32.00	34.00	36.00	38.00	40.00
PRICE:		200.74	205.38	210.01	214.65	219.29	223.93	228.56	233.20	237.84	242.48	247.11	251.75	256.39	261.03	265.66	270.30
54.00		11.25	13.50	15.75	18.00	20.25	22.50	24.75	27.00	29.25	31.50	33.75	36.00	38.25	40.50	42.75	45.00
PRICE:		217.55	222.77	227.98	233.20	238.42	243.63	248.85	254.07	259.29	264.50	269.72	274.94	280.15	285.37	290.59	295.81
60.00		12.50	15.00	17.50	20.00	22.50	25.00	27.50	30.00	32.50	35.00	37.50	40.00	42.50	45.00	47.50	50.00
PRICE:		234.36	240.16	245.95	251.75	257.55	263.34	269.14	274.94	280.73	286.53	292.33	298.13	303.92	309.72	315.52	321.31
66.00		13.75	16.50	19.25	22.00	24.75	27.50	30.25	33.00	35.75	38.50	41.25	44.00	46.75	49.50	52.25	55.00
PRICE:		251.17	257.55	263.92	270.30	276.68	283.05	289.43	295.81	302.18	308.56	314.94	321.31	327.69	334.07	340.44	346.82
72.00		15.00	18.00	21.00	24.00	27.00	30.00	33.00	36.00	39.00	42.00	45.00	48.00	51.00	54.00	57.00	60.00
PRICE:		267.98	274.94	281.89	288.85	295.81	302.76	309.72	316.68	323.63	330.59	337.54	344.50	351.46	358.41	365.37	372.33
78.00		16.25	19.50	22.75	26.00	29.25	32.50	35.75	39.00	42.25	45.50	48.75	52.00	55.25	58.50	61.75	65.00
PRICE:		284.79	292.33	299.86	307.40	314.94	322.47	330.01	337.54	345.08	352.62	360.15	367.69	375.22	382.76	390.30	397.83
84.00		17.50	21.00	24.50	28.00	31.50	35.00	38.50	42.00	45.50	49.00	52.50	56.00	59.50	63.00	66.50	70.00
PRICE:		301.60	309.72	317.83	325.95	334.07	342.18	350.30	358.41	366.53	374.64	382.76	390.88	398.99	407.11	415.22	423.34
90.00		18.75	22.50	26.25	30.00	33.75	37.50	41.25	45.00	48.75	52.50	56.25	60.00	63.75	67.50	71.25	75.00
PRICE:		318.41	327.11	335.80	344.50	353.20	361.89	370.59	379.28	387.98	396.67	405.37	414.06	422.76	431.45	440.15	448.84
96.00		20.00	24.00	28.00	32.00	36.00	40.00	44.00	48.00	52.00	56.00	60.00	64.00	68.00	72.00	76.00	80.00
PRICE:		335.23	344.50	353.78	363.05	372.33	381.60	390.88	400.15	409.43	418.70	427.98	437.25	446.53	455.80	465.08	474.35



Make the ULTIMATE First Impression in your neighbourhood!

www.valor.ca

VALOR SPECIALTY PRODUCTS INC.

1800 Courtneypark Dr. East, Units 2-4
Mississauga, ON Canada L5T 1W1

TEL: (905) 564-3122 • FAX: (905) 564-5470



SPECIALTY PRODUCTS INC.

PVC Gable Accents

...made to order

CAT: MGA		GABLE ACCENTS - SCHEDULE: 1D															
BASE (IN.)	HEIGHT (IN.)	PITCH															
		5/12	6/12	7/12	8/12	9/12	10/12	11/12	12/12	13/12	14/12	15/12	16/12	17/12	18/12	19/12	20/12
36.00		7.50	9.00	10.50	12.00	13.50	15.00	16.50	18.00	19.50	21.00	22.50	24.00	25.50	27.00	28.50	30.00
PRICE:		134.55	137.14	139.72	142.31	144.89	147.47	150.06	152.64	155.22	157.81	160.39	162.98	165.56	168.14	170.73	173.31
42.00		8.75	10.50	12.25	14.00	15.75	17.50	19.25	21.00	22.75	24.50	26.25	28.00	29.75	31.50	33.25	35.00
PRICE:		147.04	150.06	153.07	156.09	159.10	162.11	165.13	168.14	171.16	174.17	177.19	180.20	183.21	186.23	189.24	192.26
48.00		10.00	12.00	14.00	16.00	18.00	20.00	22.00	24.00	26.00	28.00	30.00	32.00	34.00	36.00	38.00	40.00
PRICE:		159.53	162.98	166.42	169.87	173.31	176.76	180.20	183.65	187.09	190.54	193.98	197.43	200.87	204.32	207.76	211.21
54.00		11.25	13.50	15.75	18.00	20.25	22.50	24.75	27.00	29.25	31.50	33.75	36.00	38.25	40.50	42.75	45.00
PRICE:		172.02	175.89	179.77	183.65	187.52	191.40	195.27	199.15	203.02	206.90	210.77	214.65	218.53	222.40	226.28	230.15
60.00		12.50	15.00	17.50	20.00	22.50	25.00	27.50	30.00	32.50	35.00	37.50	40.00	42.50	45.00	47.50	50.00
PRICE:		184.51	188.81	193.12	197.43	201.73	206.04	210.34	214.65	218.96	223.26	227.57	231.88	236.18	240.49	244.79	249.10
66.00		13.75	16.50	19.25	22.00	24.75	27.50	30.25	33.00	35.75	38.50	41.25	44.00	46.75	49.50	52.25	55.00
PRICE:		196.99	201.73	206.47	211.21	215.94	220.68	225.42	230.15	234.89	239.63	244.36	249.10	253.84	258.57	263.31	268.05
72.00		15.00	18.00	21.00	24.00	27.00	30.00	33.00	36.00	39.00	42.00	45.00	48.00	51.00	54.00	57.00	60.00
PRICE:		209.48	214.65	219.82	224.99	230.15	235.32	240.49	245.66	250.82	255.99	261.16	266.33	271.49	276.66	281.83	287.00
78.00		16.25	19.50	22.75	26.00	29.25	32.50	35.75	39.00	42.25	45.50	48.75	52.00	55.25	58.50	61.75	65.00
PRICE:		221.97	227.57	233.17	238.77	244.36	249.96	255.56	261.16	266.76	272.35	277.95	283.55	289.15	294.75	300.34	305.94
84.00		17.50	21.00	24.50	28.00	31.50	35.00	38.50	42.00	45.50	49.00	52.50	56.00	59.50	63.00	66.50	70.00
PRICE:		234.46	240.49	246.52	252.55	258.57	264.60	270.63	276.66	282.69	288.72	294.75	300.78	306.80	312.83	318.86	324.89
90.00		18.75	22.50	26.25	30.00	33.75	37.50	41.25	45.00	48.75	52.50	56.25	60.00	63.75	67.50	71.25	75.00
PRICE:		246.95	253.41	259.87	266.33	272.78	279.24	285.70	292.16	298.62	305.08	311.54	318.00	324.46	330.92	337.38	343.84
96.00		20.00	24.00	28.00	32.00	36.00	40.00	44.00	48.00	52.00	56.00	60.00	64.00	68.00	72.00	76.00	80.00
PRICE:		259.44	266.33	273.22	280.11	287.00	293.89	300.78	307.67	314.56	321.45	328.34	335.23	342.12	349.01	355.90	362.79



PAINT SCH. CODE: CALL

Make the ULTIMATE First Impression in your neighbourhood!

www.valor.ca

VALOR SPECIALTY PRODUCTS INC.

1800 Courtneypark Dr. East, Units 2-4
Mississauga, ON Canada L5T 1W1

TEL: (905) 564-3122 • FAX: (905) 564-5470



SPECIALTY PRODUCTS INC.

PVC Gable Accents

...made to order

CAT: MGA		GABLE ACCENTS - SCHEDULE: IE														
BASE (IN.)	PITCH															
	5/12	6/12	7/12	8/12	9/12	10/12	11/12	12/12	13/12	14/12	15/12	16/12	17/12	18/12	19/12	20/12
36.00	7.50	9.00	10.50	12.00	13.50	15.00	16.50	18.00	19.50	21.00	22.50	24.00	25.50	27.00	28.50	30.00
PRICE:	111.80	114.28	116.77	119.25	121.73	124.22	126.70	129.19	131.67	134.16	136.64	139.13	141.61	144.09	146.58	149.06
42.00	8.75	10.50	12.25	14.00	15.75	17.50	19.25	21.00	22.75	24.50	26.25	28.00	29.75	31.50	33.25	35.00
PRICE:	123.80	126.70	129.60	132.50	135.40	138.30	141.20	144.09	146.99	149.89	152.79	155.69	158.59	161.48	164.38	167.28
48.00	10.00	12.00	14.00	16.00	18.00	20.00	22.00	24.00	26.00	28.00	30.00	32.00	34.00	36.00	38.00	40.00
PRICE:	135.81	139.13	142.44	145.75	149.06	152.38	155.69	159.00	162.31	165.63	168.94	172.25	175.56	178.88	182.19	185.50
54.00	11.25	13.50	15.75	18.00	20.25	22.50	24.75	27.00	29.25	31.50	33.75	36.00	38.25	40.50	42.75	45.00
PRICE:	147.82	151.55	155.27	159.00	162.73	166.45	170.18	173.91	177.63	181.36	185.09	188.81	192.54	196.27	199.99	203.72
60.00	12.50	15.00	17.50	20.00	22.50	25.00	27.50	30.00	32.50	35.00	37.50	40.00	42.50	45.00	47.50	50.00
PRICE:	159.83	163.97	168.11	172.25	176.39	180.53	184.67	188.81	192.95	197.09	201.23	205.38	209.52	213.66	217.80	221.94
66.00	13.75	16.50	19.25	22.00	24.75	27.50	30.25	33.00	35.75	38.50	41.25	44.00	46.75	49.50	52.25	55.00
PRICE:	171.84	176.39	180.95	185.50	190.05	194.61	199.16	203.72	208.27	212.83	217.38	221.94	226.49	231.05	235.60	240.16
72.00	15.00	18.00	21.00	24.00	27.00	30.00	33.00	36.00	39.00	42.00	45.00	48.00	51.00	54.00	57.00	60.00
PRICE:	183.84	188.81	193.78	198.75	203.72	208.69	213.66	218.63	223.59	228.56	233.53	238.50	243.47	248.44	253.41	258.38
78.00	16.25	19.50	22.75	26.00	29.25	32.50	35.75	39.00	42.25	45.50	48.75	52.00	55.25	58.50	61.75	65.00
PRICE:	195.85	201.23	206.62	212.00	217.38	222.77	228.15	233.53	238.91	244.30	249.68	255.06	260.45	265.83	271.21	276.59
84.00	17.50	21.00	24.50	28.00	31.50	35.00	38.50	42.00	45.50	49.00	52.50	56.00	59.50	63.00	66.50	70.00
PRICE:	207.86	213.66	219.45	225.25	231.05	236.84	242.64	248.44	254.23	260.03	265.83	271.63	277.42	283.22	289.02	294.81
90.00	18.75	22.50	26.25	30.00	33.75	37.50	41.25	45.00	48.75	52.50	56.25	60.00	63.75	67.50	71.25	75.00
PRICE:	219.87	226.08	232.29	238.50	244.71	250.92	257.13	263.34	269.55	275.77	281.98	288.19	294.40	300.61	306.82	313.03
96.00	20.00	24.00	28.00	32.00	36.00	40.00	44.00	48.00	52.00	56.00	60.00	64.00	68.00	72.00	76.00	80.00
PRICE:	231.88	238.50	245.13	251.75	258.38	265.00	271.63	278.25	284.88	291.50	298.13	304.75	311.38	318.00	324.63	331.25
102.00	21.25	25.50	29.75	34.00	38.25	42.50	46.75	51.00	55.25	59.50	63.75	68.00	72.25	76.50	80.75	85.00
PRICE:	243.88	250.92	257.96	265.00	272.04	279.08	286.12	293.16	300.20	307.23	314.27	321.31	328.35	335.39	342.43	349.47
108.00	22.50	27.00	31.50	36.00	40.50	45.00	49.50	54.00	58.50	63.00	67.50	72.00	76.50	81.00	85.50	90.00
PRICE:	255.89	263.34	270.80	278.25	285.70	293.16	300.61	308.06	315.52	322.97	330.42	337.88	345.33	352.78	360.23	367.69
114.00	23.75	28.50	33.25	38.00	42.75	47.50	52.25	57.00	61.75	66.50	71.25	76.00	80.75	85.50	90.25	95.00
PRICE:	267.90	275.77	283.63	291.50	299.37	307.23	315.10	322.97	330.84	338.70	346.57	354.44	362.30	370.17	378.04	385.91
120.00	25.00	30.00	35.00	40.00	45.00	50.00	55.00	60.00	65.00	70.00	75.00	80.00	85.00	90.00	95.00	100.00
PRICE:	279.91	288.19	296.47	304.75	313.03	321.31	329.59	337.88	346.16	354.44	362.72	371.00	379.28	387.56	395.84	404.13



PAINT SCH. CODE: CALL

Make the **ULTIMATE** First Impression in your neighbourhood!

www.valor.ca

VALOR SPECIALTY PRODUCTS INC.

1800 Courtneypark Dr. East, Units 2-4
Mississauga, ON Canada L5T 1W1

TEL: (905) 564-3122 • FAX: (905) 564-5470

PVC Gable Accents

...made to order

CAT: MGA		GABLE ACCENTS - SCHEDULE: 1F														
BASE (IN.)	PITCH															
	5/12	6/12	7/12	8/12	9/12	10/12	11/12	12/12	13/12	14/12	15/12	16/12	17/12	18/12	19/12	20/12
36.00	7.50	9.00	10.50	12.00	13.50	15.00	16.50	18.00	19.50	21.00	22.50	24.00	25.50	27.00	28.50	30.00
PRICE:	148.10	151.38	154.66	157.94	161.22	164.50	167.78	171.06	174.34	177.62	180.90	184.18	187.45	190.73	194.01	197.29
42.00	8.75	10.50	12.25	14.00	15.75	17.50	19.25	21.00	22.75	24.50	26.25	28.00	29.75	31.50	33.25	35.00
PRICE:	163.95	167.78	171.60	175.43	179.26	183.08	186.91	190.73	194.56	198.39	202.21	206.04	209.86	213.69	217.52	221.34
48.00	10.00	12.00	14.00	16.00	18.00	20.00	22.00	24.00	26.00	28.00	30.00	32.00	34.00	36.00	38.00	40.00
PRICE:	179.80	184.18	188.55	192.92	197.29	201.67	206.04	210.41	214.78	219.16	223.53	227.90	232.27	236.65	241.02	245.39
54.00	11.25	13.50	15.75	18.00	20.25	22.50	24.75	27.00	29.25	31.50	33.75	36.00	38.25	40.50	42.75	45.00
PRICE:	195.65	200.57	205.49	210.41	215.33	220.25	225.17	230.09	235.01	239.92	244.84	249.76	254.68	259.60	264.52	269.44
60.00	12.50	15.00	17.50	20.00	22.50	25.00	27.50	30.00	32.50	35.00	37.50	40.00	42.50	45.00	47.50	50.00
PRICE:	211.50	216.97	222.43	227.90	233.37	238.83	244.30	249.76	255.23	260.69	266.16	271.63	277.09	282.56	288.02	293.49
66.00	13.75	16.50	19.25	22.00	24.75	27.50	30.25	33.00	35.75	38.50	41.25	44.00	46.75	49.50	52.25	55.00
PRICE:	227.35	233.37	239.38	245.39	251.40	257.41	263.43	269.44	275.45	281.46	287.48	293.49	299.50	305.51	311.52	317.54
72.00	15.00	18.00	21.00	24.00	27.00	30.00	33.00	36.00	39.00	42.00	45.00	48.00	51.00	54.00	57.00	60.00
PRICE:	243.20	249.76	256.32	262.88	269.44	276.00	282.56	289.12	295.67	302.23	308.79	315.35	321.91	328.47	335.03	341.59
78.00	16.25	19.50	22.75	26.00	29.25	32.50	35.75	39.00	42.25	45.50	48.75	52.00	55.25	58.50	61.75	65.00
PRICE:	259.05	266.16	273.26	280.37	287.48	294.58	301.69	308.79	315.90	323.00	330.11	337.21	344.32	351.42	358.53	365.63
84.00	17.50	21.00	24.50	28.00	31.50	35.00	38.50	42.00	45.50	49.00	52.50	56.00	59.50	63.00	66.50	70.00
PRICE:	274.90	282.56	290.21	297.86	305.51	313.16	320.82	328.47	336.12	343.77	351.42	359.08	366.73	374.38	382.03	389.68
90.00	18.75	22.50	26.25	30.00	33.75	37.50	41.25	45.00	48.75	52.50	56.25	60.00	63.75	67.50	71.25	75.00
PRICE:	290.75	298.95	307.15	315.35	323.55	331.75	339.95	348.14	356.34	364.54	372.74	380.94	389.14	397.33	405.53	413.73
96.00	20.00	24.00	28.00	32.00	36.00	40.00	44.00	48.00	52.00	56.00	60.00	64.00	68.00	72.00	76.00	80.00
PRICE:	306.61	315.35	324.10	332.84	341.59	350.33	359.08	367.82	376.57	385.31	394.06	402.80	411.55	420.29	429.04	437.78
102.00	21.25	25.50	29.75	34.00	38.25	42.50	46.75	51.00	55.25	59.50	63.75	68.00	72.25	76.50	80.75	85.00
PRICE:	322.46	331.75	341.04	350.33	359.62	368.91	378.20	387.50	396.79	406.08	415.37	424.66	433.95	443.25	452.54	461.83
108.00	22.50	27.00	31.50	36.00	40.50	45.00	49.50	54.00	58.50	63.00	67.50	72.00	76.50	81.00	85.50	90.00
PRICE:	338.31	348.14	357.98	367.82	377.66	387.50	397.33	407.17	417.01	426.85	436.69	446.53	456.36	466.20	476.04	485.88
114.00	23.75	28.50	33.25	38.00	42.75	47.50	52.25	57.00	61.75	66.50	71.25	76.00	80.75	85.50	90.25	95.00
PRICE:	354.16	364.54	374.93	385.31	395.69	406.08	416.46	426.85	437.23	447.62	458.00	468.39	478.77	489.16	499.54	509.93
120.00	25.00	30.00	35.00	40.00	45.00	50.00	55.00	60.00	65.00	70.00	75.00	80.00	85.00	90.00	95.00	100.00
PRICE:	370.01	380.94	391.87	402.80	413.73	424.66	435.59	446.53	457.46	468.39	479.32	490.25	501.18	512.11	523.04	533.98
126.00	26.25	31.50	36.75	42.00	47.25	52.50	57.75	63.00	68.25	73.50	78.75	84.00	89.25	94.50	99.75	105.00
PRICE:	385.86	397.33	408.81	420.29	431.77	443.25	454.72	466.20	477.68	489.16	500.63	512.11	523.59	535.07	546.55	558.02
132.00	27.50	33.00	38.50	44.00	49.50	55.00	60.50	66.00	71.50	77.00	82.50	88.00	93.50	99.00	104.50	110.00
PRICE:	401.71	413.73	425.76	437.78	449.80	461.83	473.85	485.88	497.90	509.93	521.95	533.98	546.00	558.02	570.05	582.07
138.00	28.75	34.50	40.25	46.00	51.75	57.50	63.25	69.00	74.75	80.50	86.25	92.00	97.75	103.50	109.25	115.00
PRICE:	417.56	430.13	442.70	455.27	467.84	480.41	492.98	505.55	518.12	530.70	543.27	555.84	568.41	580.98	593.55	606.12
144.00	30.00	36.00	42.00	48.00	54.00	60.00	66.00	72.00	78.00	84.00	90.00	96.00	102.00	108.00	114.00	120.00
PRICE:	433.41	446.53	459.64	472.76	485.88	499.00	512.11	525.23	538.35	551.47	564.58	577.70	590.82	603.94	617.05	630.17



PAINT SCH. CODE: CALL

Make the **ULTIMATE** First Impression in your neighbourhood!

www.valor.ca

VALOR SPECIALTY PRODUCTS INC.

1800 Courtneypark Dr. East, Units 2-4
Mississauga, ON Canada L5T 1W1

TEL: (905) 564-3122 • FAX: (905) 564-5470



SPECIALTY PRODUCTS INC.

PVC Gable Accents

...made to order

CAT: MGA		GABLE ACCENTS - SCHEDULE: 16															
BASE (IN.)	HEIGHT (IN.)	PITCH															
		5/12	6/12	7/12	8/12	9/12	10/12	11/12	12/12	13/12	14/12	15/12	16/12	17/12	18/12	19/12	20/12
36.00		7.50	9.00	10.50	12.00	13.50	15.00	16.50	18.00	19.50	21.00	22.50	24.00	25.50	27.00	28.50	30.00
PRICE:		127.93	138.34	141.08	143.82	146.56	149.30	152.04	154.78	157.51	160.25	162.99	165.73	168.47	171.21	173.95	176.69
42.00		8.75	10.50	12.25	14.00	15.75	17.50	19.25	21.00	22.75	24.50	26.25	28.00	29.75	31.50	33.25	35.00
PRICE:		148.84	152.04	155.23	158.43	161.62	164.82	168.01	171.21	174.40	177.60	180.79	183.99	187.18	190.38	193.58	196.77
48.00		10.00	12.00	14.00	16.00	18.00	20.00	22.00	24.00	26.00	28.00	30.00	32.00	34.00	36.00	38.00	40.00
PRICE:		162.08	165.73	169.38	173.03	176.69	180.34	183.99	187.64	191.29	194.94	198.60	202.25	205.90	209.55	213.20	216.85
54.00		11.25	13.50	15.75	18.00	20.25	22.50	24.75	27.00	29.25	31.50	33.75	36.00	38.25	40.50	42.75	45.00
PRICE:		175.32	179.42	183.53	187.64	191.75	195.86	199.97	204.07	208.18	212.29	216.40	220.51	224.61	228.72	232.83	236.94
60.00		12.50	15.00	17.50	20.00	22.50	25.00	27.50	30.00	32.50	35.00	37.50	40.00	42.50	45.00	47.50	50.00
PRICE:		188.55	193.12	197.68	202.25	206.81	211.38	215.94	220.51	225.07	229.64	234.20	238.77	243.33	247.89	252.46	257.02
66.00		13.75	16.50	19.25	22.00	24.75	27.50	30.25	33.00	35.75	38.50	41.25	44.00	46.75	49.50	52.25	55.00
PRICE:		201.79	206.81	211.83	216.85	221.88	226.90	231.92	236.94	241.96	246.98	252.00	257.02	262.04	267.07	272.09	277.11
72.00		15.00	18.00	21.00	24.00	27.00	30.00	33.00	36.00	39.00	42.00	45.00	48.00	51.00	54.00	57.00	60.00
PRICE:		215.03	220.51	225.98	231.46	236.94	242.42	247.89	253.37	258.85	264.33	269.80	275.28	280.76	286.24	291.71	297.19
78.00		16.25	19.50	22.75	26.00	29.25	32.50	35.75	39.00	42.25	45.50	48.75	52.00	55.25	58.50	61.75	65.00
PRICE:		228.27	234.20	240.13	246.07	252.00	257.94	263.87	269.80	275.74	281.67	287.61	293.54	299.47	305.41	311.34	317.28
84.00		17.50	21.00	24.50	28.00	31.50	35.00	38.50	42.00	45.50	49.00	52.50	56.00	59.50	63.00	66.50	70.00
PRICE:		241.50	247.89	254.28	260.68	267.07	273.46	279.85	286.24	292.63	299.02	305.41	311.80	318.19	324.58	330.97	337.36
90.00		18.75	22.50	26.25	30.00	33.75	37.50	41.25	45.00	48.75	52.50	56.25	60.00	63.75	67.50	71.25	75.00
PRICE:		254.74	261.59	268.44	275.28	282.13	288.98	295.82	302.67	309.52	316.36	323.21	330.06	336.90	343.75	350.60	357.45
96.00		20.00	24.00	28.00	32.00	36.00	40.00	44.00	48.00	52.00	56.00	60.00	64.00	68.00	72.00	76.00	80.00
PRICE:		267.98	275.28	282.59	289.89	297.19	304.50	311.80	319.10	326.41	333.71	341.01	348.32	355.62	362.92	370.23	377.53



Make the ULTIMATE First Impression in your neighbourhood!

www.valor.ca

VALOR SPECIALTY PRODUCTS INC.

1800 Courtneypark Dr. East, Units 2-4
Mississauga, ON Canada L5T 1W1

TEL: (905) 564-3122 • FAX: (905) 564-5470



SPECIALTY PRODUCTS INC.

PVC Gable Accents

...made to order

CAT: MGA		GABLE ACCENTS - SCHEDULE: IH															
BASE (IN.)	HEIGHT (IN.)	PITCH															
		5/12	6/12	7/12	8/12	9/12	10/12	11/12	12/12	13/12	14/12	15/12	16/12	17/12	18/12	19/12	20/12
36.00		7.50	9.00	10.50	12.00	13.50	15.00	16.50	18.00	19.50	21.00	22.50	24.00	25.50	27.00	28.50	30.00
PRICE:		194.78	198.75	202.73	206.70	210.68	214.65	218.63	222.60	226.58	230.55	234.53	238.50	242.48	246.45	250.43	254.40
42.00		8.75	10.50	12.25	14.00	15.75	17.50	19.25	21.00	22.75	24.50	26.25	28.00	29.75	31.50	33.25	35.00
PRICE:		213.99	218.63	223.26	227.90	232.54	237.18	241.81	246.45	251.09	255.73	260.36	265.00	269.64	274.28	278.91	283.55
48.00		10.00	12.00	14.00	16.00	18.00	20.00	22.00	24.00	26.00	28.00	30.00	32.00	34.00	36.00	38.00	40.00
PRICE:		233.20	238.50	243.80	249.10	254.40	259.70	265.00	270.30	275.60	280.90	286.20	291.50	296.80	302.10	307.40	312.70
54.00		11.25	13.50	15.75	18.00	20.25	22.50	24.75	27.00	29.25	31.50	33.75	36.00	38.25	40.50	42.75	45.00
PRICE:		252.41	258.38	264.34	270.30	276.26	282.23	288.19	294.15	300.11	306.08	312.04	318.00	323.96	329.93	335.89	341.85
60.00		12.50	15.00	17.50	20.00	22.50	25.00	27.50	30.00	32.50	35.00	37.50	40.00	42.50	45.00	47.50	50.00
PRICE:		271.63	278.25	284.88	291.50	298.13	304.75	311.38	318.00	324.63	331.25	337.88	344.50	351.13	357.75	364.38	371.00
66.00		13.75	16.50	19.25	22.00	24.75	27.50	30.25	33.00	35.75	38.50	41.25	44.00	46.75	49.50	52.25	55.00
PRICE:		290.84	298.13	305.41	312.70	319.99	327.28	334.56	341.85	349.14	356.43	363.71	371.00	378.29	385.58	392.86	400.15
72.00		15.00	18.00	21.00	24.00	27.00	30.00	33.00	36.00	39.00	42.00	45.00	48.00	51.00	54.00	57.00	60.00
PRICE:		310.05	318.00	325.95	333.90	341.85	349.80	357.75	365.70	373.65	381.60	389.55	397.50	405.45	413.40	421.35	429.30
78.00		16.25	19.50	22.75	26.00	29.25	32.50	35.75	39.00	42.25	45.50	48.75	52.00	55.25	58.50	61.75	65.00
PRICE:		329.26	337.88	346.49	355.10	363.71	372.33	380.94	389.55	398.16	406.78	415.39	424.00	432.61	441.23	449.84	458.45
84.00		17.50	21.00	24.50	28.00	31.50	35.00	38.50	42.00	45.50	49.00	52.50	56.00	59.50	63.00	66.50	70.00
PRICE:		348.48	357.75	367.03	376.30	385.58	394.85	404.13	413.40	422.68	431.95	441.23	450.50	459.78	469.05	478.33	487.60
90.00		18.75	22.50	26.25	30.00	33.75	37.50	41.25	45.00	48.75	52.50	56.25	60.00	63.75	67.50	71.25	75.00
PRICE:		367.69	377.63	387.56	397.50	407.44	417.38	427.31	437.25	447.19	457.13	467.06	477.00	486.94	496.88	506.81	516.75
96.00		20.00	24.00	28.00	32.00	36.00	40.00	44.00	48.00	52.00	56.00	60.00	64.00	68.00	72.00	76.00	80.00
PRICE:		386.90	397.50	408.10	418.70	429.30	439.90	450.50	461.10	471.70	482.30	492.90	503.50	514.10	524.70	535.30	545.90



PAINT SCH. CODE: CALL

Make the ULTIMATE First Impression in your neighbourhood!

www.valor.ca

VALOR SPECIALTY PRODUCTS INC.

1800 Courtneypark Dr. East, Units 2-4
Mississauga, ON Canada L5T 1W1

TEL: (905) 564-3122 • FAX: (905) 564-5470

PVC Gable Accents

CAT: MGA		MODELS: MGA-500, MGA-511	
PRODUCT NO.	DESCRIPTION	PACKAGING (per box)	PRICE (each)
MGA-50101630	MGA-500 Gable Accent Adjustable Pitch	1	165.95
	MIN 9/12 Pitch W - 84.00 x H - 33.00in		
	MAX 16/12 Pitch W - 63.00 x H - 42.75in		
MGA-51101630	MGA-511 Gable Accent Adjustable Pitch	1	116.95
	MIN 10/12 Pitch W - 46.70 x H - 26.50in		
	MAX 16/12 Pitch W - 28.00 x H - 36.40in		
MGA-63114072	MGA-631 @14/12P-42.0x72.0in (2-pc FLG)	1 (KD)*	159.95
MGA-63110120	MGA-630 @10/12P-50.0x120.0in (2-pc FLG)	1 (KD)*	319.95
MGA-66814078	MGA-668 @14/12P-45.5x78.0in (No FLG)	1 (KD)*	232.95
MGA-66810114	MGA-668 @10/12P-47.5x114.0in (No FLG)	1 (KD)*	292.95
MGA-67314078	MGA-673 @14/12P-45.5x78.0in (No FLG)	1 (KD)*	342.95
MGA-67310114	MGA-673 @10/12P-47.5x114.0in (No FLG)	1 (KD)*	449.95
MGA-69210072	MGA-692 @10/12P-30.0x72.0in (No FLG)	1 (KD)*	195.95
MGA-69212072	MGA-692 @12/12P-36.0x72.0in (No FLG)	1 (KD)*	303.43

*(KD) Models Can Be shipped partially or fully unassembled to aid in shipping and customizing on site.
(FLG) Nailing Flange

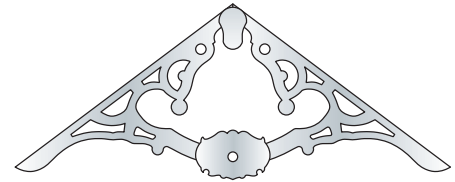

MGA-500

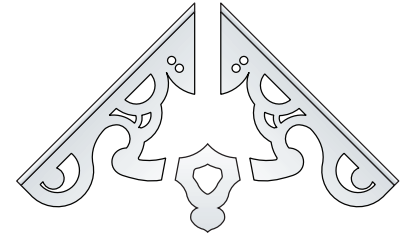

MGA-511

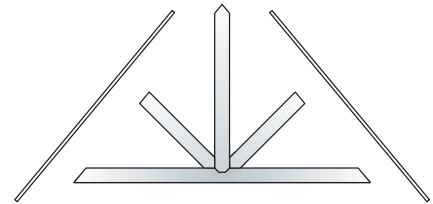

MGA-630

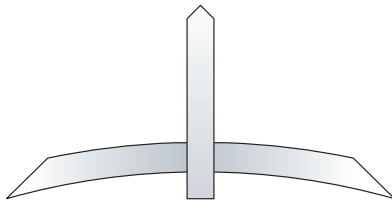

MGA-668

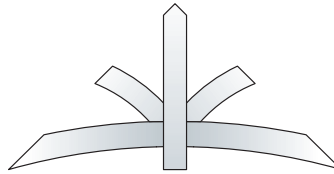

MGA-673

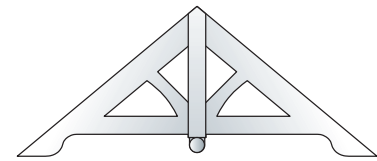

MGA-692

CAT: MGA		GABLE POST	
PRODUCT NO.	DESCRIPTION	PACKAGING (per box)	PRICE (each)
MGA-91025036	PVC Gable Post-Type:02 2.5 x 2.5 x 36in	1	59.00
MGA-91025042	PVC Gable Post-Type:02 2.5 x 2.5 x 42in	1	63.00
MGA-91035042	PVC Gable Post-Type:01 3.5 x 3.5 x 42in	1	69.00
MGA-91035048	PVC Gable Post-Type:01 3.5 x 3.5 x 48in	1	74.25
MGA-91035060	PVC Gable Post-Type:01 3.5 x 3.5 x 60in	1	83.48



2.50"
Gable Post



3.50"
Gable Post



Make the ULTIMATE First Impression in your neighbourhood!

www.valor.ca

VALOR SPECIALTY PRODUCTS INC.

1800 Courtneypark Dr. East, Units 2-4
Mississauga, ON Canada L5T 1W1

TEL: (905) 564-3122 • FAX: (905) 564-5470



SPECIALTY PRODUCTS INC.

PVC Square Plain Straight Column Wraps



CAT: MCC		PVC SQUARE PLAIN STRAIGHT COLUMN WRAPS - (1/2" MATERIAL-SMOOTH)		
PRODUCT NO.	DESCRIPTION	DIMENSION (Inside)	PACKAGING (per box)	PRICE* (each)
MCC-101006072	PVC Wrap SQR Pln 5.50x72.00in	4.50	1	119.31
MCC-101006096	PVC Wrap SQR Pln 5.50x96.00in	4.50	1	143.97
MCC-101006108	PVC Wrap SQR Pln 5.50x108.00in	4.50	1	156.29
MCC-101006120	PVC Wrap SQR Pln 5.50x120.00in	4.50	1	168.62
MCC-101008096	PVC Wrap SQR PLN 7.25x96.00in	6.25	1	175.34
MCC-101008108	PVC Wrap SQR PLN 7.25x108.00in	6.25	1	191.59
MCC-101008120	PVC Wrap SQR PLN 7.25x120.00in	6.25	1	207.84
MCC-101008144	PVC Wrap SQR PLN 7.25x144.00in	6.25	1	240.33
MCC-101010096	PVC Wrap SQR PLN 9.25x96.00in	8.25	1	211.20
MCC-101010108	PVC Wrap SQR PLN 9.25x108.00in	8.25	1	231.93
MCC-101010120	PVC Wrap SQR PLN 9.25x120.00in	8.25	1	252.66
MCC-101010144	PVC Wrap SQR PLN 9.25x144.00in	8.25	1	294.12
MCC-101012096	PVC Wrap SQR PLN 11.25x96.00in	10.25	1	247.05
MCC-101012108	PVC Wrap SQR PLN 11.25x108.00in	10.25	1	272.27
MCC-101012120	PVC Wrap SQR PLN 11.25x120.00in	10.25	1	297.48
MCC-101012144	PVC Wrap SQR PLN 11.25x144.00in	10.25	1	347.90

CAT: MCC		PVC SQUARE PLAIN STRAIGHT COLUMN WRAP - (5/8" MATERIAL-SMOOTH)		
PRODUCT NO.	DESCRIPTION	DIMENSION (Inside)	PACKAGING (per box)	PRICE* (each)
MCC-101106060	PVC Wrap SQR Pln 5.50x60.00in	4.25	1	121.15
MCC-101106072	PVC Wrap SQR Pln 5.50x72.00in	4.25	1	136.25
MCC-101106096	PVC Wrap SQR Pln 5.50x96.00in	4.25	1	166.55
MCC-101106108	PVC Wrap SQR Pln 5.50x108.00in	4.25	1	181.70
MCC-101106120	PVC Wrap SQR Pln 5.50x120.00in	4.25	1	196.84
MCC-101108072	PVC Wrap SQR PLN 7.25x72.00in	6.00	1	165.00
MCC-101108096	PVC Wrap SQR PLN 7.25x96.00in	6.00	1	205.11
MCC-101108108	PVC Wrap SQR PLN 7.25x108.00in	6.00	1	225.08
MCC-101108120	PVC Wrap SQR PLN 7.25x120.00in	6.00	1	245.04
MCC-101108144	PVC Wrap SQR PLN 7.25x144.00in	6.00	1	284.98
MCC-101110072	PVC Wrap SQR PLN 9.25x72.00in	8.00	1	198.00
MCC-101110096	PVC Wrap SQR PLN 9.25x96.00in	8.00	1	249.18
MCC-101110108	PVC Wrap SQR PLN 9.25x108.00in	8.00	1	274.65
MCC-101110120	PVC Wrap SQR PLN 9.25x120.00in	8.00	1	300.13
MCC-101110144	PVC Wrap SQR PLN 9.25x144.00in	8.00	1	351.08
MCC-101112072	PVC Wrap SQR PLN 11.25x72.00in	10.00	1	231.25
MCC-101112096	PVC Wrap SQR PLN 11.25x96.00in	10.00	1	293.24
MCC-101112108	PVC Wrap SQR PLN 11.25x108.00in	10.00	1	324.23
MCC-101112120	PVC Wrap SQR PLN 11.25x120.00in	10.00	1	355.21
MCC-101112144	PVC Wrap SQR PLN 11.25x144.00in	10.00	1	417.18
MCC-101116072	PVC Wrap SQR PLN 15.25x72.00in	14.00	1	313.25
MCC-101116096	PVC Wrap SQR PLN 15.25x96.00in	14.00	1	397.50
MCC-101116108	PVC Wrap SQR PLN 15.25x108.00in	14.00	1	439.51
MCC-101116120	PVC Wrap SQR PLN 15.25x120.00in	14.00	1	481.51
MCC-101116144	PVC Wrap SQR PLN 15.25x144.00in	14.00	1	565.52

*Prices above do not include Caps, Bases, or Inserts / SOLD SEPARATELY.



IMPORTANT NOTE !

Column Wraps can be produced and sold in a KD (Knock-Down Unassembled) or SPLIT "L" (2-L Sections) Construction. ALL orders will be produced and shipped in a KD format unless otherwise specified on your order. Any order specified as SPLIT "L" may have additional packaging and shipping charges applied to your order. Please contact our office for specific impact to your order.



PAINT SCH. CODE: 2A

Make the **ULTIMATE** First Impression in your neighbourhood!

www.valor.ca

VALOR SPECIALTY PRODUCTS INC.

1800 Courtneypark Dr. East, Units 2-4
Mississauga, ON Canada L5T 1W1

TEL: (905) 564-3122 • FAX: (905) 564-5470

PVC Square Fluted Straight Column Wraps

CAT: MCC
PVC SQUARE FLUTED STRAIGHT COLUMN WRAPS (FLUTE TEMPLATE 01) - (5/8" MATERIAL SMOOTH)

PRODUCT NO.	DESCRIPTION	DIMENSION (Inside)	PACKAGING (per box)	PRICE* (each)
MCC-102106072	PVC Wrap SQR FLT1 5.50x72.00in	4.25	1	140.38
MCC-102106096	PVC Wrap SQR FLT1 5.50x96.00in	4.25	1	172.06
MCC-102106108	PVC Wrap SQR FLT1 5.50x108.00in	4.25	1	187.89
MCC-102106120	PVC Wrap SQR FLT1 5.50x120.00in	4.25	1	203.73
MCC-102108072	PVC Wrap SQR FLT1 7.25x72.00in	6.00	1	170.62
MCC-102108096	PVC Wrap SQR FLT1 7.25x96.00in	6.00	1	212.37
MCC-102108108	PVC Wrap SQR FLT1 7.25x108.00in	6.00	1	233.24
MCC-102108120	PVC Wrap SQR FLT1 7.25x120.00in	6.00	1	254.12
MCC-102108144	PVC Wrap SQR FLT1 7.25x144.00in	6.00	1	295.87
MCC-102110072	PVC Wrap SQR FLT1 9.25x72.00in	8.00	1	205.17
MCC-102110096	PVC Wrap SQR FLT1 9.25x96.00in	8.00	1	258.44
MCC-102110108	PVC Wrap SQR FLT1 9.25x108.00in	8.00	1	285.07
MCC-102110120	PVC Wrap SQR FLT1 9.25x120.00in	8.00	1	311.71
MCC-102110144	PVC Wrap SQR FLT1 9.25x144.00in	8.00	1	364.98
MCC-102112072	PVC Wrap SQR FLT1 11.25x72.00in	10.00	1	239.72
MCC-102112096	PVC Wrap SQR FLT1 11.25x96.00in	10.00	1	304.51
MCC-102112108	PVC Wrap SQR FLT1 11.25x108.00in	10.00	1	336.90
MCC-102112120	PVC Wrap SQR FLT1 11.25x120.00in	10.00	1	369.30
MCC-102112144	PVC Wrap SQR FLT1 11.25x144.00in	10.00	1	434.09

CAT: MCC
PVC SQUARE FLUTED STRAIGHT COLUMN WRAPS (FLUTE TEMPLATE 02) - (5/8" MATERIAL SMOOTH)

PRODUCT NO.	DESCRIPTION	DIMENSION (Inside)	PACKAGING (per box)	PRICE* (each)
MCC-102206072	PVC Wrap SQR FLT2 5.50x72.00in	4.25	1	140.38
MCC-102206096	PVC Wrap SQR FLT2 5.50x96.00in	4.25	1	172.06
MCC-102206108	PVC Wrap SQR FLT2 5.50x108.00in	4.25	1	187.89
MCC-102206120	PVC Wrap SQR FLT2 5.50x120.00in	4.25	1	203.73
MCC-102208096	PVC Wrap SQR FLT2 7.25x96.00in	6.00	1	212.37
MCC-102208108	PVC Wrap SQR FLT2 7.25x108.00in	6.00	1	233.24
MCC-102208120	PVC Wrap SQR FLT2 7.25x120.00in	6.00	1	254.12
MCC-102208144	PVC Wrap SQR FLT2 7.25x144.00in	6.00	1	295.87
MCC-102210096	PVC Wrap SQR FLT2 9.25x96.00in	8.00	1	258.44
MCC-102210108	PVC Wrap SQR FLT2 9.25x108.00in	8.00	1	285.07
MCC-102210120	PVC Wrap SQR FLT2 9.25x120.00in	8.00	1	311.71
MCC-102210144	PVC Wrap SQR FLT2 9.25x144.00in	8.00	1	364.98
MCC-102212096	PVC Wrap SQR FLT2 11.25x96.00in	10.00	1	304.51
MCC-102212108	PVC Wrap SQR FLT2 11.25x108.00in	10.00	1	336.90
MCC-102212120	PVC Wrap SQR FLT2 11.25x120.00in	10.00	1	369.30
MCC-102212144	PVC Wrap SQR FLT2 11.25x144.00in	10.00	1	434.09

CAT: MCC
PVC SQUARE FLUTED STRAIGHT COLUMN WRAPS (FLUTE TEMPLATE 03) - (5/8" MATERIAL SMOOTH)

PRODUCT NO.	DESCRIPTION	DIMENSION (Inside)	PACKAGING (per box)	PRICE* (each)
MCC-102306072	PVC Wrap SQR FLT3 5.50x72.00in	4.25	1	140.38
MCC-102306096	PVC Wrap SQR FLT3 5.50x96.00in	4.25	1	172.06
MCC-102306108	PVC Wrap SQR FLT3 5.50x108.00in	4.25	1	187.89
MCC-102306120	PVC Wrap SQR FLT3 5.50x120.00in	4.25	1	203.73
MCC-102308096	PVC Wrap SQR FLT3 7.25x96.00in	6.00	1	212.37
MCC-102308108	PVC Wrap SQR FLT3 7.25x108.00in	6.00	1	233.24
MCC-102308120	PVC Wrap SQR FLT3 7.25x120.00in	6.00	1	254.12
MCC-102308144	PVC Wrap SQR FLT3 7.25x144.00in	6.00	1	295.87
MCC-102310096	PVC Wrap SQR FLT3 9.25x96.00in	8.00	1	258.44
MCC-102310108	PVC Wrap SQR FLT3 9.25x108.00in	8.00	1	285.07
MCC-102310120	PVC Wrap SQR FLT3 9.25x120.00in	8.00	1	311.71
MCC-102310144	PVC Wrap SQR FLT3 9.25x144.00in	8.00	1	364.98
MCC-102312096	PVC Wrap SQR FLT3 11.25x96.00in	10.00	1	304.51
MCC-102312108	PVC Wrap SQR FLT3 11.25x108.00in	10.00	1	336.90
MCC-102312120	PVC Wrap SQR FLT3 11.25x120.00in	10.00	1	369.30
MCC-102312144	PVC Wrap SQR FLT3 11.25x144.00in	10.00	1	434.09



PVC Square Fluted Straight Column Wrap (Flute Template 01)



PVC Square Fluted Straight Column Wrap (Flute Template 02)

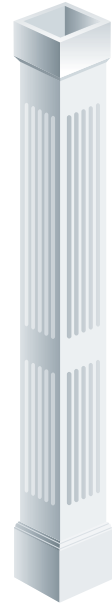

PVC Square Fluted Straight Column Wrap (Flute Template 03)

*Prices above do not include Caps, Bases, or Inserts / SOLD SEPARATELY.

IMPORTANT NOTE !

Column Wraps can be produced and sold in a KD (Knock-Down Unassembled) or SPLIT "L" (2-L Sections) Construction. ALL orders will be produced and shipped in a KD format unless otherwise specified on your order. Any order specified as SPLIT "L" may have additional packaging and shipping charges applied to your order. Please contact our office for specific impact to your order.

Make the **ULTIMATE** First Impression in your neighbourhood!

PVC Square Raised Panel Straight Column Wraps

CAT: MCC PVC SQUARE RAISED PANEL STRAIGHT COLUMN WRAPS (PLUNGE ROUTE TEMPLATE 01) 5/8" MATERIAL				
PRODUCT NO.	DESCRIPTION	DIMENSION (Inside)	PACKAGING (per box)	PRICE* (each)
MCC-103106072	PVC Wrap SQR RP01 5.50x72.00in	4.25	1	146.86
MCC-103106096	PVC Wrap SQR RP01 5.50x96.00in	4.25	1	178.54
MCC-103106108	PVC Wrap SQR RP01 5.50x108.00in	4.25	1	194.37
MCC-103106120	PVC Wrap SQR RP01 5.50x120.00in	4.25	1	210.21
MCC-103108096	PVC Wrap SQR RP01 7.25x96.00in	6.00	1	218.85
MCC-103108108	PVC Wrap SQR RP01 7.25x108.00in	6.00	1	239.72
MCC-103108120	PVC Wrap SQR RP01 7.25x120.00in	6.00	1	260.60
MCC-103108144	PVC Wrap SQR RP01 7.25x144.00in	6.00	1	302.35
MCC-103110096	PVC Wrap SQR RP01 9.25x96.00in	8.00	1	264.92
MCC-103110108	PVC Wrap SQR RP01 9.25x108.00in	8.00	1	291.55
MCC-103110120	PVC Wrap SQR RP01 9.25x120.00in	8.00	1	318.19
MCC-103110144	PVC Wrap SQR RP01 9.25x144.00in	8.00	1	371.46
MCC-103112096	PVC Wrap SQR RP01 11.25x96.00in	10.00	1	310.99
MCC-103112108	PVC Wrap SQR RP01 11.25x108.00in	10.00	1	343.38
MCC-103112120	PVC Wrap SQR RP01 11.25x120.00in	10.00	1	375.78
MCC-103112144	PVC Wrap SQR RP01 11.25x144.00in	10.00	1	440.57

CAT: MCC PVC SQUARE RAISED PANEL STRAIGHT COLUMN WRAPS (PLUNGE ROUTE TEMPLATE 03) 5/8" MATERIAL				
PRODUCT NO.	DESCRIPTION	DIMENSION (Inside)	PACKAGING (per box)	PRICE* (each)
MCC-103306072	PVC Wrap SQR RP03 5.50x72.00in	4.25	1	146.86
MCC-103306096	PVC Wrap SQR RP03 5.50x96.00in	4.25	1	178.54
MCC-103306108	PVC Wrap SQR RP03 5.50x108.00in	4.25	1	194.37
MCC-103306120	PVC Wrap SQR RP03 5.50x120.00in	4.25	1	210.21
MCC-103308096	PVC Wrap SQR RP03 7.25x96.00in	6.00	1	218.85
MCC-103308108	PVC Wrap SQR RP03 7.25x108.00in	6.00	1	239.72
MCC-103308120	PVC Wrap SQR RP03 7.25x120.00in	6.00	1	260.60
MCC-103308144	PVC Wrap SQR RP03 7.25x144.00in	6.00	1	302.35
MCC-103310096	PVC Wrap SQR RP03 9.25x96.00in	8.00	1	264.92
MCC-103310108	PVC Wrap SQR RP03 9.25x108.00in	8.00	1	291.55
MCC-103310120	PVC Wrap SQR RP03 9.25x120.00in	8.00	1	318.19
MCC-103310144	PVC Wrap SQR RP03 9.25x144.00in	8.00	1	371.46
MCC-103312096	PVC Wrap SQR RP03 11.25x96.00in	10.00	1	310.99
MCC-103312108	PVC Wrap SQR RP03 11.25x108.00in	10.00	1	343.38
MCC-103312120	PVC Wrap SQR RP03 11.25x120.00in	10.00	1	375.78
MCC-103312144	PVC Wrap SQR RP03 11.25x144.00in	10.00	1	440.57

CAT: MCC PVC SQUARE RAISED PANEL STRAIGHT COLUMN WRAPS (PLUNGE ROUTE TEMPLATE 02) 5/8" MATERIAL				
PRODUCT NO.	DESCRIPTION	DIMENSION (Inside)	PACKAGING (per box)	PRICE* (each)
MCC-103206072	PVC Wrap SQR RP02 5.50x72.00in	4.25	1	146.86
MCC-103206096	PVC Wrap SQR RP02 5.50x96.00in	4.25	1	178.54
MCC-103206108	PVC Wrap SQR RP02 5.50x108.00in	4.25	1	194.37
MCC-103206120	PVC Wrap SQR RP02 5.50x120.00in	4.25	1	210.21
MCC-103208096	PVC Wrap SQR RP02 7.25x96.00in	6.00	1	218.85
MCC-103208108	PVC Wrap SQR RP02 7.25x108.00in	6.00	1	239.72
MCC-103208120	PVC Wrap SQR RP02 7.25x120.00in	6.00	1	260.60
MCC-103208144	PVC Wrap SQR RP02 7.25x144.00in	6.00	1	302.35
MCC-103210096	PVC Wrap SQR RP02 9.25x96.00in	8.00	1	264.92
MCC-103210108	PVC Wrap SQR RP02 9.25x108.00in	8.00	1	291.55
MCC-103210120	PVC Wrap SQR RP02 9.25x120.00in	8.00	1	318.19
MCC-103210144	PVC Wrap SQR RP02 9.25x144.00in	8.00	1	371.46
MCC-103212096	PVC Wrap SQR RP02 11.25x96.00in	10.00	1	310.99
MCC-103212108	PVC Wrap SQR RP02 11.25x108.00in	10.00	1	343.38
MCC-103212120	PVC Wrap SQR RP02 11.25x120.00in	10.00	1	375.78
MCC-103212144	PVC Wrap SQR RP02 11.25x144.00in	10.00	1	440.57

*Prices above do not include Caps, Bases, or Inserts / SOLD SEPARATELY.

IMPORTANT NOTE !

Column Wraps can be produced and sold in a KD (Knock-Down Unassembled) or SPLIT "L" (2-L Sections) Construction. ALL orders will be produced and shipped in a KD format unless otherwise specified on your order. Any order specified as SPLIT "L" may have additional packaging and shipping charges applied to your order. Please contact our office for specific impact to your order.

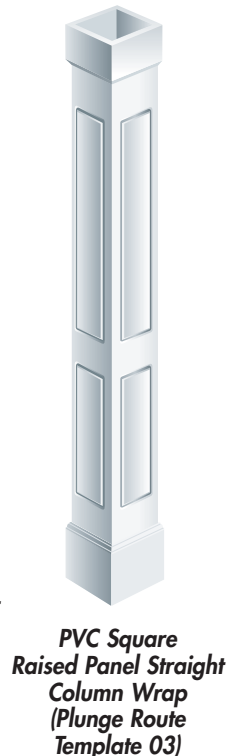
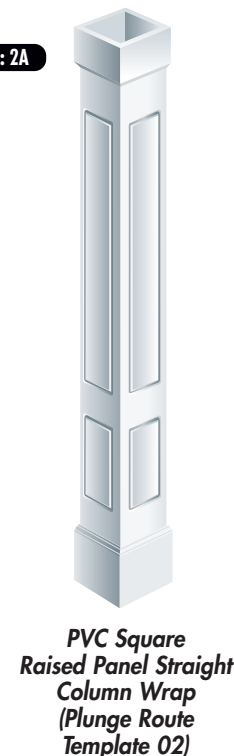
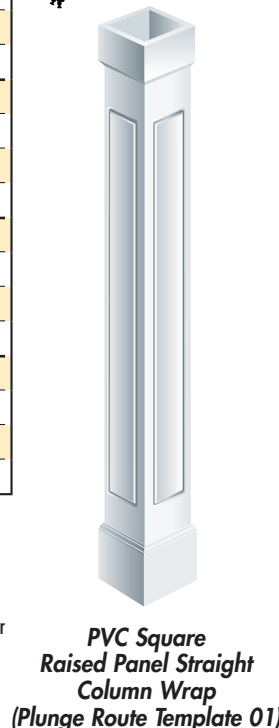

Make the **ULTIMATE** First Impression in your neighbourhood!

www.valor.ca

VALOR SPECIALTY PRODUCTS INC.

1800 Courtneypark Dr. East, Units 2-4
Mississauga, ON Canada L5T 1W1

TEL: (905) 564-3122 • FAX: (905) 564-5470

PVC Square Recessed Panel Straight Column Wraps

CAT: MCC PVC SQUARE RECESSED PANEL REC-01 STRAIGHT COLUMN WRAPS (5/8" MATERIAL)				
PRODUCT NO.	DESCRIPTION	DIMENSION (Inside)	PACKAGING (per box)	PRICE* (each)
MCC-104106072	PVC Wrap SQR REC01 5.50x72.00in	4.25	1	178.41
MCC-104106096	PVC Wrap SQR REC01 5.50x96.00in	4.25	1	221.10
MCC-104106108	PVC Wrap SQR REC01 5.50x108.00in	4.25	1	242.45
MCC-104106120	PVC Wrap SQR REC01 5.50x120.00in	4.25	1	263.80
MCC-104108096	PVC Wrap SQR REC01 7.25x96.00in	6.00	1	276.22
MCC-104108108	PVC Wrap SQR REC01 7.25x108.00in	6.00	1	305.36
MCC-104108120	PVC Wrap SQR REC01 7.25x120.00in	6.00	1	334.50
MCC-104108144	PVC Wrap SQR REC01 7.25x144.00in	6.00	1	392.78
MCC-104110096	PVC Wrap SQR REC01 9.25x96.00in	8.00	1	339.21
MCC-104110108	PVC Wrap SQR REC01 9.25x108.00in	8.00	1	377.26
MCC-104110120	PVC Wrap SQR REC01 9.25x120.00in	8.00	1	415.30
MCC-104110144	PVC Wrap SQR REC01 9.25x144.00in	8.00	1	491.39
MCC-104112096	PVC Wrap SQR REC01 11.25x96.00in	10.00	1	402.20
MCC-104112108	PVC Wrap SQR REC01 11.25x108.00in	10.00	1	449.15
MCC-104112120	PVC Wrap SQR REC01 11.25x120.00in	10.00	1	496.11
MCC-104112144	PVC Wrap SQR REC01 11.25x144.00in	10.00	1	590.01

CAT: MCC PVC SQUARE RECESSED PANEL REC-03 STRAIGHT COLUMN WRAPS (5/8" MATERIAL)				
PRODUCT NO.	DESCRIPTION	DIMENSION (Inside)	PACKAGING (per box)	PRICE* (each)
MCC-104306072	PVC Wrap SQR REC03 5.50x72.00in	4.25	1	178.41
MCC-104306096	PVC Wrap SQR REC03 5.50x96.00in	4.25	1	221.10
MCC-104306108	PVC Wrap SQR REC03 5.50x108.00in	4.25	1	242.45
MCC-104306120	PVC Wrap SQR REC03 5.50x120.00in	4.25	1	263.80
MCC-104308096	PVC Wrap SQR REC03 7.25x96.00in	6.00	1	276.22
MCC-104308108	PVC Wrap SQR REC03 7.25x108.00in	6.00	1	305.36
MCC-104308120	PVC Wrap SQR REC03 7.25x120.00in	6.00	1	334.50
MCC-104308144	PVC Wrap SQR REC03 7.25x144.00in	6.00	1	392.78
MCC-104310096	PVC Wrap SQR REC03 9.25x96.00in	8.00	1	339.21
MCC-104310108	PVC Wrap SQR REC03 9.25x108.00in	8.00	1	377.26
MCC-104310120	PVC Wrap SQR REC03 9.25x120.00in	8.00	1	415.30
MCC-104310144	PVC Wrap SQR REC03 9.25x144.00in	8.00	1	491.39
MCC-104312096	PVC Wrap SQR REC03 11.25x96.00in	10.00	1	402.20
MCC-104312108	PVC Wrap SQR REC03 11.25x108.00in	10.00	1	449.15
MCC-104312120	PVC Wrap SQR REC03 11.25x120.00in	10.00	1	496.11
MCC-104312144	PVC Wrap SQR REC03 11.25x144.00in	10.00	1	590.01

CAT: MCC PVC SQUARE RECESSED PANEL REC-02 STRAIGHT COLUMN WRAPS (5/8" MATERIAL)				
PRODUCT NO.	DESCRIPTION	DIMENSION (Inside)	PACKAGING (per box)	PRICE* (each)
MCC-104206072	PVC Wrap SQR REC02 5.50x72.00in	4.25	1	178.41
MCC-104206096	PVC Wrap SQR REC02 5.50x96.00in	4.25	1	221.10
MCC-104206108	PVC Wrap SQR REC02 5.50x108.00in	4.25	1	242.45
MCC-104206120	PVC Wrap SQR REC02 5.50x120.00in	4.25	1	263.80
MCC-104208096	PVC Wrap SQR REC02 7.25x96.00in	6.00	1	276.22
MCC-104208108	PVC Wrap SQR REC02 7.25x108.00in	6.00	1	305.36
MCC-104208120	PVC Wrap SQR REC02 7.25x120.00in	6.00	1	334.50
MCC-104208144	PVC Wrap SQR REC02 7.25x144.00in	6.00	1	392.78
MCC-104210096	PVC Wrap SQR REC02 9.25x96.00in	8.00	1	339.21
MCC-104210108	PVC Wrap SQR REC02 9.25x108.00in	8.00	1	377.26
MCC-104210120	PVC Wrap SQR REC02 9.25x120.00in	8.00	1	415.30
MCC-104210144	PVC Wrap SQR REC02 9.25x144.00in	8.00	1	491.39
MCC-104212096	PVC Wrap SQR REC02 11.25x96.00in	10.00	1	402.20
MCC-104212108	PVC Wrap SQR REC02 11.25x108.00in	10.00	1	449.15
MCC-104212120	PVC Wrap SQR REC02 11.25x120.00in	10.00	1	496.11
MCC-104212144	PVC Wrap SQR REC02 11.25x144.00in	10.00	1	590.01

*Prices above do not include Caps, Bases, or Inserts / SOLD SEPARATELY.

IMPORTANT NOTE !

Column Wraps can be produced and sold in a KD (Knock-Down Unassembled) or SPLIT "L" (2-L Sections) Construction. ALL orders will be produced and shipped in a KD format unless otherwise specified on your order. Any order specified as SPLIT "L" may have additional packaging and shipping charges applied to your order. Please contact our office for specific impact to your order.

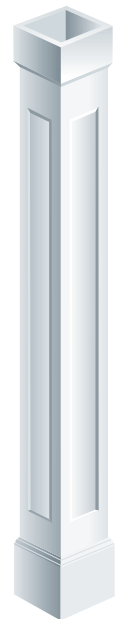

PVC Square Recessed Panel Straight Column Wrap REC-01

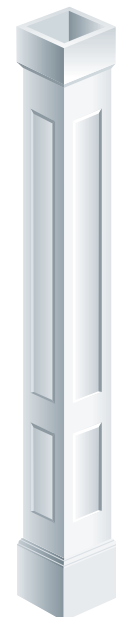

PVC Square Recessed Panel Straight Column Wrap REC-02



PVC Square Recessed Panel Straight Column Wrap REC-03

Make the **ULTIMATE** First Impression in your neighbourhood!

PVC Square Tapered Column Wraps



PAINT SCH. CODE: 2A

CAT: MCC PVC SQUARE TAPERED SMOOTH PANEL COLUMN WRAPS (1/2" MATERIAL)

PRODUCT NO.	DESCRIPTION	DIMENSION (Inside)	PACKAGING (per box)	PRICE* (each)
MCC-1500610048	PVC Wrap TPRD Pln 6x10x48.00in	5.00	1	145.56
MCC-1500610060	PVC Wrap TPRD Pln 6x10x60.00in	5.00	1	168.99
MCC-1500610072	PVC Wrap TPRD Pln 6x10x72.00in	5.00	1	192.41
MCC-1500610096	PVC Wrap TPRD Pln 6x10x96.00in	5.00	1	239.27
MCC-1500610108	PVC Wrap TPRD Pln 6x10x108.00in	5.00	1	262.70
MCC-1500610120	PVC Wrap TPRD Pln 6x10x120.00in	5.00	1	286.13
MCC-1500812048	PVC Wrap TPRD Pln 8x12x48.00in	7.00	1	164.30
MCC-1500812060	PVC Wrap TPRD Pln 8x12x60.00in	7.00	1	192.41
MCC-1500812072	PVC Wrap TPRD Pln 8x12x72.00in	7.00	1	220.53
MCC-1500812096	PVC Wrap TPRD Pln 8x12x96.00in	7.00	1	276.76
MCC-1500812108	PVC Wrap TPRD Pln 8x12x108.00in	7.00	1	304.87
MCC-1500812120	PVC Wrap TPRD Pln 8x12x120.00in	7.00	1	332.99
MCC-1500812144	PVC Wrap TPRD Pln 8x12x144.00in	7.00	1	389.22
MCC-1501014072	PVC Wrap TPRD Pln 10x14x72.00in	9.00	1	248.64
MCC-1501014096	PVC Wrap TPRD Pln 10x14x96.00in	9.00	1	314.25
MCC-1501014108	PVC Wrap TPRD Pln 10x14x108.00in	9.00	1	347.05
MCC-1501014120	PVC Wrap TPRD Pln 10x14x120.00in	9.00	1	379.85
MCC-1501014144	PVC Wrap TPRD Pln 10x14x144.00in	9.00	1	445.45
MCC-1501216072	PVC Wrap TPRD Pln 12x16x72.00in	11.00	1	276.76
MCC-1501216096	PVC Wrap TPRD Pln 12x16x96.00in	11.00	1	351.73
MCC-1501216108	PVC Wrap TPRD Pln 12x16x108.00in	11.00	1	389.22
MCC-1501216120	PVC Wrap TPRD Pln 12x16x120.00in	11.00	1	426.71
MCC-1501216144	PVC Wrap TPRD Pln 12x16x144.00in	11.00	1	501.68

CAT: MCC PVC SQUARE TAPERED RAISED PANEL COLUMN WRAPS (PLUNGE 5/8" MATERIAL)

MCC-1520610048	PVC Wrap TPRD RP 6x10x48.00in	4.75	1	179.98
MCC-1520610060	PVC Wrap TPRD RP 6x10x60.00in	4.75	1	208.77
MCC-1520610072	PVC Wrap TPRD RP 6x10x72.00in	4.75	1	237.57
MCC-1520610096	PVC Wrap TPRD RP 6x10x96.00in	4.75	1	295.16
MCC-1520610108	PVC Wrap TPRD RP 6x10x108.00in	4.75	1	323.95
MCC-1520610120	PVC Wrap TPRD RP 6x10x120.00in	4.75	1	352.75
MCC-1520812048	PVC Wrap TPRD RP 8x12x48.00in	6.75	1	203.01
MCC-1520812060	PVC Wrap TPRD RP 8x12x60.00in	6.75	1	237.57
MCC-1520812072	PVC Wrap TPRD RP 8x12x72.00in	6.75	1	272.12
MCC-1520812096	PVC Wrap TPRD RP 8x12x96.00in	6.75	1	341.23
MCC-1520812108	PVC Wrap TPRD RP 8x12x108.00in	6.75	1	375.78
MCC-1520812120	PVC Wrap TPRD RP 8x12x120.00in	6.75	1	410.33
MCC-1520812144	PVC Wrap TPRD RP 8x12x144.00in	6.75	1	479.44
MCC-1521014060	PVC Wrap TPRD RP 10x14x60.00in	8.75	1	265.95
MCC-1521014072	PVC Wrap TPRD RP 10x14x72.00in	8.75	1	306.67
MCC-1521014096	PVC Wrap TPRD RP 10x14x96.00in	8.75	1	387.30
MCC-1521014108	PVC Wrap TPRD RP 10x14x108.00in	8.75	1	427.61
MCC-1521014120	PVC Wrap TPRD RP 10x14x120.00in	8.75	1	467.92
MCC-1521014144	PVC Wrap TPRD RP 10x14x144.00in	8.75	1	548.55
MCC-1521216060	PVC Wrap TPRD RP 12x16x60.00in	10.75	1	295.25
MCC-1521216072	PVC Wrap TPRD RP 12x16x72.00in	10.75	1	341.23
MCC-1521216096	PVC Wrap TPRD RP 12x16x96.00in	10.75	1	433.37
MCC-1521216108	PVC Wrap TPRD RP 12x16x108.00in	10.75	1	479.44
MCC-1521216120	PVC Wrap TPRD RP 12x16x120.00in	10.75	1	525.51
MCC-1521216144	PVC Wrap TPRD RP 12x16x144.00in	10.75	1	617.65

CAT: MCC PVC SQUARE TAPERED RECESSED PANEL COLUMN WRAPS (5/8" MATERIAL)

PRODUCT NO.	DESCRIPTION	DIMENSION (Inside)	PACKAGING (per box)	PRICE* (each)
MCC-1530610048	PVC Wrap TPRD REC 6x10x48.00in	4.75	1	253.75
MCC-1530610060	PVC Wrap TPRD REC 6x10x60.00in	4.75	1	295.13
MCC-1530610072	PVC Wrap TPRD REC 6x10x72.00in	4.75	1	336.52
MCC-1530610096	PVC Wrap TPRD REC 6x10x96.00in	4.75	1	419.29
MCC-1530610108	PVC Wrap TPRD REC 6x10x108.00in	4.75	1	460.67
MCC-1530610120	PVC Wrap TPRD REC 6x10x120.00in	4.75	1	502.06
MCC-1530812048	PVC Wrap TPRD REC 8x12x48.00in	6.75	1	285.50
MCC-1530812060	PVC Wrap TPRD REC 8x12x60.00in	6.75	1	335.79
MCC-1530812072	PVC Wrap TPRD REC 8x12x72.00in	6.75	1	386.09
MCC-1530812096	PVC Wrap TPRD REC 8x12x96.00in	6.75	1	486.67
MCC-1530812108	PVC Wrap TPRD REC 8x12x108.00in	6.75	1	536.96
MCC-1530812120	PVC Wrap TPRD REC 8x12x120.00in	6.75	1	587.26
MCC-1530812144	PVC Wrap TPRD REC 8x12x144.00in	6.75	1	687.84
MCC-1531014072	PVC Wrap TPRD REC 10x14x72.00in	8.75	1	435.66
MCC-1531014096	PVC Wrap TPRD REC 10x14x96.00in	8.75	1	554.06
MCC-1531014108	PVC Wrap TPRD REC 10x14x108.00in	8.75	1	613.25
MCC-1531014120	PVC Wrap TPRD REC 10x14x120.00in	8.75	1	672.45
MCC-1531014144	PVC Wrap TPRD REC 10x14x144.00in	8.75	1	790.85
MCC-1531216072	PVC Wrap TPRD REC 12x16x72.00in	10.75	1	485.23
MCC-1531216096	PVC Wrap TPRD REC 12x16x96.00in	10.75	1	621.44
MCC-1531216108	PVC Wrap TPRD REC 12x16x108.00in	10.75	1	689.54
MCC-1531216120	PVC Wrap TPRD REC 12x16x120.00in	10.75	1	757.65
MCC-1531216144	PVC Wrap TPRD REC 12x16x144.00in	10.75	1	893.86

*Prices above do not include Caps, Bases, or Inserts / SOLD SEPARATELY.

IMPORTANT NOTE !

Column Wraps can be produced and sold in a KD (Knock-Down Unassembled) or SPLIT "L" (2-L Sections) Construction. ALL orders will be produced and shipped in a KD format unless otherwise specified on your order. Any order specified as SPLIT "L" may have additional packaging and shipping charges applied to your order. Please contact our office for specific impact to your order.



PVC Square Tapered Panel Column Wrap



PVC Square Tapered Raised Panel Column Wrap



PVC Square Tapered Recessed Panel Column Wrap



SPECIALTY PRODUCTS INC.

PVC Square Half Column Piers

- Piers are designed to wrap our Standard Square Load Bearing Columns
- Piers can be shipped as a full assembled Sleeve, or KD.
- Internal Spacers conform the Size Column you wish to use it with.
- Piers include a standard 3/4" Top Cap with opening for the Column Size required (to be specified)
- Optional Caps are available



CAT: MCC	PVC SQUARE FLUTED PANEL FLT01 PIER (5/8"FRAME)		
PRODUCT NO.	DESCRIPTION	PACKAGING (per box)	PRICE* (each)
MCC-202112038	PVC SQR Flute(FLT01) Pier 11.25x38.00in	1	222.64
MCC-202112044	PVC SQR Flute(FLT01) Pier 11.25x44.00in	1	242.64
MCC-202116038	PVC SQR Flute(FLT01) Pier 15.25x38.00in	1	267.67
MCC-202116044	PVC SQR Flute(FLT01) Pier 15.25x44.00in	1	294.78
MCC-202120038	PVC SQR Flute(FLT01) Pier 20.25x38.00in	1	323.96
MCC-202120044	PVC SQR Flute(FLT01) Pier 20.25x44.00in	1	359.95
MCC-202124038	PVC SQR Flute(FLT01) Pier 23.25x38.00in	1	357.73
MCC-202124044	PVC SQR Flute(FLT01) Pier 23.25x44.00in	1	399.05

CAT: MCC	PVC SQUARE RAISED PANEL RP01 PIER (5/8"FRAME)		
PRODUCT NO.	DESCRIPTION	PACKAGING (per box)	PRICE* (each)
MCC-203112038	PVC SQR RSD Panel(RP01) Pier 11.25x38.00in	1	206.64
MCC-203112044	PVC SQR RSD Panel(RP01) Pier 11.25x44.00in	1	226.64
MCC-203116038	PVC SQR RSD Panel(RP01) Pier 15.25x38.00in	1	251.67
MCC-203116044	PVC SQR RSD Panel(RP01) Pier 15.25x44.00in	1	278.78
MCC-203120038	PVC SQR RSD Panel(RP01) Pier 20.25x38.00in	1	307.96
MCC-203120044	PVC SQR RSD Panel(RP01) Pier 20.25x44.00in	1	343.95
MCC-203124038	PVC SQR RSD Panel(RP01) Pier 23.25x38.00in	1	341.73
MCC-203124044	PVC SQR RSD Panel(RP01) Pier 23.25x44.00in	1	383.05

CAT: MCC	PVC SQUARE RECESSED PANEL REC-01 PIER (5/8"FRAME, 3/8" PANEL MATERIAL)		
PRODUCT NO.	DESCRIPTION	PACKAGING (per box)	PRICE* (each)
MCC-204112038	PVC SQR Rec.Panel(REC01) Pier 11.25x38.00in	1	231.33
MCC-204112044	PVC SQR Rec.Panel(REC01) Pier 11.25x44.00in	1	259.34
MCC-204116038	PVC SQR Rec.Panel(REC01) Pier 15.25x38.00in	1	280.56
MCC-204116044	PVC SQR Rec.Panel(REC01) Pier 15.25x44.00in	1	319.57
MCC-204120038	PVC SQR Rec.Panel(REC01) Pier 20.25x38.00in	1	342.11
MCC-204120044	PVC SQR Rec.Panel(REC01) Pier 20.25x44.00in	1	394.86
MCC-204124038	PVC SQR Rec.Panel(REC01) Pier 23.25x38.00in	1	379.04
MCC-204124044	PVC SQR Rec.Panel(REC01) Pier 23.25x44.00in	1	440.04

* Includes 3/4in Cap; does not include Cap or Base for Column

PVC Square Fluted Panel

PVC Square Raised Panel

PVC Square Recessed Panel

Top Cap

Columns Pier Wraps can be manufactured with inserts to receive multiple size columns, please specify your requirement when placing your order.

IMPORTANT NOTE !

Column Wraps can be produced and sold in a KD (Knock-Down Unassembled) or SPLIT "L" (2-L Sections) Construction. ALL orders will be produced and shipped in a KD format unless otherwise specified on your order. Any order specified as SPLIT "L" may have additional packaging and shipping charges applied to your order. Please contact our office for specific impact to your order.



PAINT SCH. CODE: 2A

Make the ULTIMATE First Impression in your neighbourhood!

www.valor.ca

VALOR SPECIALTY PRODUCTS INC.

1800 Courtneypark Dr. East, Units 2-4
Mississauga, ON Canada L5T 1W1

TEL: (905) 564-3122 • FAX: (905) 564-5470

PVC Square Post Wrap Accessories

CAT: MCA		PVC COLUMN ACCESSORIES	
PRODUCT NO.	DESCRIPTION	PACKAGING (per box)	PRICE (each)
MCA-316060010	5.50in PVC SQR Low Prof. Trim	1	18.74
MCA-316060020	5.50in PVC SQR Crown Trim	1	27.00
MCA-316060030	5.50in PVC SQR Colonial Casing Trim	1	27.00
MCA-316060040	5.50in PVC SQR Colonial Box Trim	1	30.46
MCA-316060070	5.50in PVC SQR Bead Base Cap	1	16.20
MCA-318060101	5.50in PVC SQR OGEE Trim Ring	1	19.98
MCA-320060101	5.50in x 0.625in PVC SQR Mounting Skirt	1	17.23
MCA-3170600401	5.50in x 3.50in PVC SQR Box Cap/Base	1	15.23
MCA-3170600601	5.50in x 5.50in PVC SQR Box Cap/Base	1	21.77
MCA-3170600801	5.50in x 7.25in PVC SQR Box Cap/Base	1	27.50
MCA-3170601001	5.50in x 9.25in PVC SQR Box Cap/Base	1	34.03
MCA-3170601201	5.50in x 11.25in PVC SQR Box Cap/Base	1	40.58
MCA-3210600401	5.50in x 3.50in SQR Classic BOX Cap/Base	1	16.75
MCA-3210600601	5.50in x 5.50in SQR Classic BOX Cap/Base	1	23.95
MCA-3210600801	5.50in x 7.25in SQR Classic BOX Cap/Base	1	30.25
MCA-3210601001	5.50in x 9.25in SQR Classic BOX Cap/Base	1	37.43
MCA-3210601201	5.50in x 11.25in SQR Classic BOX Cap/Base	1	44.64
MCA-3210601601	5.50in x 15.25in SQR Classic BOX Cap/Base	1	59.80
	Custom SQR Classic BOX Cap	Quote	Quote
MCA-316080010	7.25in PVC SQR Low Prof. Trim	1	20.61
MCA-316080020	7.25in PVC SQR Crown Trim	1	30.22
MCA-316080030	7.25in PVC SQR Colonial Casing Trim	1	30.22
MCA-316080040	7.25in PVC SQR Colonial Box Trim	1	34.34
MCA-316080070	7.25in PVC SQR Bead Base Cap	1	16.74
MCA-318080101	7.25in PVC SQR OGEE Trim Ring	1	22.32
MCA-320080101	7.25in x 0.625in PVC SQR Mounting Skirt	1	23.49
MCA-3170800401	7.25in x 3.50in PVC SQR Box Cap/Base	1	18.32
MCA-3170800601	7.25in x 5.50in PVC SQR Box Cap/Base	1	26.43
MCA-3170800801	7.25in x 7.25in PVC SQR Box Cap/Base	1	33.51
MCA-3170801001	7.25in x 9.25in PVC SQR Box Cap/Base	1	41.64
MCA-3170801201	7.25in x 11.25in PVC SQR Box Cap/Base	1	49.74
MCA-3170700702	7.25in x 7.25in PVC SQR Box Cap/Base, w/Notch	1	40.22
MCA-3170701202	7.25in x 11.25in PVC SQR Box Cap/Base, w/Notch	1	59.69
MCA-3210800401	7.25in x 3.50in SQR Classic BOX Cap/Base	1	20.15
MCA-3210800601	7.25in x 5.50in SQR Classic BOX Cap/Base	1	29.07
MCA-3210800801	7.25in x 7.25in SQR Classic BOX Cap/Base	1	36.86
MCA-3210801001	7.25in x 9.25in SQR Classic BOX Cap/Base	1	45.80
MCA-3210801201	7.25in x 11.25in SQR Classic BOX Cap/Base	1	54.71
MCA-3210801601	7.25inx 15.25in SQR Classic BOX Cap/Base	1	73.80
	Custom SQR Classic BOX Cap	Quote	Quote

CAT: MCA		PVC COLUMN ACCESSORIES	
PRODUCT NO.	DESCRIPTION	PACKAGING (per box)	PRICE (each)
MCA-316090010	9.25in PVC SQR Low Prof. Trim	1	25.19
MCA-316090020	9.25in PVC SQR Crown Trim	1	37.09
MCA-316090030	9.25in PVC SQR Colonial Casing Trim	1	37.09
MCA-316090040	9.25in PVC SQR Colonial Box Trim	1	42.11
MCA-316090070	9.25in PVC SQR Bead Base Cap	1	19.48
MCA-318090101	9.25in PVC SQR OGEE Trim Ring	1	29.25
MCA-320090101	9.25in x 0.625in PVC SQR Mounting Skirt	1	29.75
MCA-3170900401	9.25in x 3.50in SQR Box Cap/Base	1	21.91
MCA-3170900601	9.25in x 5.50in SQR Box Cap/Base	1	37.42
MCA-3170900801	9.25in x 7.25in SQR Box Cap/Base	1	40.98
MCA-3170901001	9.25in x 9.25in SQR Box Cap/Base	1	51.14
MCA-3170901201	9.25in x 11.25in SQR Box Cap/Base	1	61.31
MCA-3210900401	9.25in x 3.50in SQR Classic BOX Cap/Base	1	24.10
MCA-3210900601	9.25in x 5.50in SQR Classic BOX Cap/Base	1	41.16
MCA-3210900801	9.25in x 7.25in SQR Classic BOX Cap/Base	1	45.08
MCA-3210901001	9.25in x 9.25in SQR Classic BOX Cap/Base	1	56.25
MCA-3210901201	9.25in x 11.25in SQR Classic BOX Cap/Base	1	67.44
MCA-3210901601	9.25in x 15.25in SQR Classic BOX Cap/Base	1	89.80
	Custom SQR Classic BOX Cap	Quote	Quote
MCA-316120010	11.25in PVC SQR Low Prof. Trim	1	28.08
MCA-316120020	11.25in PVC SQR Crown Trim	1	40.77
MCA-316120030	11.25in PVC SQR Colonial Casing Trim	1	40.77
MCA-316120040	11.25in PVC SQR Colonial Box Trim	1	46.39
MCA-316120070	11.25in PVC SQR Bead Base Cap	1	22.90
MCA-318120101	11.25in PVC SQR OGEE Trim Ring	1	25.92
MCA-320120101	11.25in x 0.625in PVC SQR Mounting Skirt	1	35.24
MCA-3171200401	11.25in x 3.50in PVC SQR Box Cap/Base	1	24.46
MCA-3171200601	11.25in x 5.50in PVC SQR Box Cap/Base	1	36.29
MCA-3171200801	11.25in x 7.25in PVC SQR Box Cap/Base	1	46.62
MCA-3171201001	11.25in x 9.25in PVC SQR Box Cap/Base	1	58.45
MCA-3171201201	11.25in x 11.25in PVC SQR Box Cap/Base	1	70.26
MCA-3211200401	11.25inx 3.50in SQR Classic BOX Cap/Base	1	26.91
MCA-3211200601	11.25inx 5.50in SQR Classic BOX Cap/Base	1	39.92
MCA-3211200801	11.25inx 7.25in SQR Classic BOX Cap/Base	1	51.28
MCA-3211201001	11.25inx 9.25in SQR Classic BOX Cap/Base	1	64.30
MCA-3211201201	11.25inx 11.25in SQR Classic BOX Cap/Base	1	77.29
MCA-3211201601	11.25inx 15.25in SQR Classic BOX Cap/Base	1	102.80
	Custom SQR Classic BOX Cap	Quote	Quote

Make the **ULTIMATE** First Impression in your neighbourhood!

www.valor.ca

VALOR SPECIALTY PRODUCTS INC.

1800 Courtneypark Dr. East, Units 2-4

Mississauga, ON Canada L5T 1W1

TEL: (905) 564-3122 • FAX: (905) 564-5470



SPECIALTY PRODUCTS INC.

PVC Square Post Wrap Accessories

CAT: MCA		PVC COLUMN ACCESSORIES	
PRODUCT NO.	DESCRIPTION	PACKAGING (per box)	PRICE (each)
MCA-316160010	15.25in PVC SQR Low Prof. Trim	1	32.67
MCA-316160020	15.25in PVC SQR Crown Trim	1	47.25
MCA-316160030	15.25in PVC SQR Colonial Casing Trim	1	47.25
MCA-316160040	15.25in PVC SQR Colonial Box Trim	1	56.16
MCA-316160070	15.25in PVC SQR Bead Base Cap	1	25.38
MCA-318160101	15.25in PVC SQR OGEE Trim Ring	1	28.84
MCA-320160101	15.25in x 0.625in PVC SQR Mounting Skirt	1	47.77
MCA-3171600401	15.25in x 3.50in PVC SQR Box Cap/Base	1	30.89
MCA-3171600601	15.25in x 5.50in PVC SQR Box Cap/Base	1	46.39
MCA-3171600801	15.25in x 7.25in PVC SQR Box Cap/Base	1	59.94
MCA-3171601001	15.25in x 9.25in PVC SQR Box Cap/Base	1	75.44
MCA-3171601201	15.25in x 11.25in PVC SQR Box Cap/Base	1	90.93
MCA-3211600401	15.25inx 3.50in SQR Classic BOX Cap/Base	1	33.98
MCA-3211600601	15.25inx 5.50in SQR Classic BOX Cap/Base	1	51.03
MCA-3211600801	15.25inx 7.25in SQR Classic BOX Cap/Base	1	65.93
MCA-3211601001	15.25inx 9.25in SQR Classic BOX Cap/Base	1	82.98
MCA-3211601201	15.25inx 11.25in SQR Classic BOX Cap/Base	1	100.02
MCA-3211601601	15.25inx 15.25in SQR Classic BOX Cap/Base	1	138.80
MCA-350108004	PVC Low Profile TPRD Column Trim - up to 8in	4-pc Kit	17.66
MCA-350110004	PVC Low Profile TPRD Column Trim - up to 10in	4-pc Kit	22.08
MCA-350112004	PVC Low Profile TPRD Column Trim - up to 12in	4-pc Kit	26.50
MCA-350116004	PVC Low Profile TPRD Column Trim - up to 16in	4-pc Kit	31.00
MCA-355035048	1/2 x 3.50 x 48.0in Lineal Column Trim w/OGEE	2-pc Kit	20.75

See product images Section 2 page 3.

IMPORTANT NOTE !

All PVC Post Wrap Accessories can be produced and sold in a KD (Knock-Down Unassembled) or SPLIT "L" (2-L Sections) Construction. ALL orders will be produced and shipped in a KD format unless otherwise specified on your order. Any order specified as SPLIT "L" may have additional packaging and shipping charges applied to your order. Please contact our office for specific impact to your order.



Make the ULTIMATE First Impression in your neighbourhood!

www.valor.ca

VALOR SPECIALTY PRODUCTS INC.

1800 Courtneypark Dr. East, Units 2-4
Mississauga, ON Canada L5T 1W1

TEL: (905) 564-3122 • FAX: (905) 564-5470



SPECIALTY PRODUCTS INC.

PVC Louvers

3/4in PVC Sheet, Double Layered

CAT: MLV	OCTAGON LOUVERS		
PRODUCT NO.	DESCRIPTION	WIDTH (in)	PRICE (each)
MLV-110108016	Octagon 16in.-Typ:01-NF-Solid	16	61.33
MLV-110109018	Octagon 18in.-Typ:01-NF-Solid	18	67.00
MLV-110110020	Octagon 20in.-Typ:01-NF-Solid	20	73.33
MLV-110112024	Octagon 24in.-Typ:01-NF-Solid	24	88.00
MLV-110114028	Octagon 28in.-Typ:01-NF-Solid	28	105.33
MLV-110115030	Octagon 30in.-Typ:01-NF-Solid	30	115.00
MLV-110116032	Octagon 32in.-Typ:01-NF-Solid	32	125.33
MLV-110118036	Octagon 36in.-Typ:01-NF-Solid	36	148.00
MLV-110120040	Octagon 40in.-Typ:01-NF-Solid	40	173.33
MLV-110121042	Octagon 42in.-Typ:01-NF-Solid	42	187.00
MLV-110122044	Octagon 44in.-Typ:01-NF-Solid	44	201.33

CAT: MLV	ROUND TOP LOUVERS			
PRODUCT NO.	DESCRIPTION	WIDTH (in)	HEIGHT (in)	PRICE (each)
MLV-112110016	Round Top 10x16in.-Typ:01-NF-Solid	10	16	56.60
MLV-112112018	Round Top 12x18in.-Typ:01-NF-Solid	12	18	61.71
MLV-112114022	Round Top 14x22in.-Typ:01-NF-Solid	14	22	67.74
MLV-112116024	Round Top 16x24in.-Typ:01-NF-Solid	16	24	74.71
MLV-112118028	Round Top 18x28in.-Typ:01-NF-Solid	18	28	82.60
MLV-112120030	Round Top 20x30in.-Typ:01-NF-Solid	20	30	91.42
MLV-112122034	Round Top 22x34in.-Typ:01-NF-Solid	22	34	101.16
MLV-112124038	Round Top 24x38in.-Typ:01-NF-Solid	24	38	121.84
MLV-112128042	Round Top 28x42in.-Typ:01-NF-Solid	28	42	155.98
MLV-112132048	Round Top 32x48in.-Typ:01-NF-Solid	32	48	183.83
MLV-112136054	Round Top 36x54in.-Typ:01-NF-Solid	36	54	215.39

CAT: MLV	ROUND LOUVERS		
PRODUCT NO.	DESCRIPTION	WIDTH (in)	PRICE (each)
MLV-111108016	Round 16in.-Typ:01-NF-Solid	16	61.33
MLV-111109018	Round 18in.-Typ:01-NF-Solid	18	67.00
MLV-111110020	Round 20in.-Typ:01-NF-Solid	20	73.33
MLV-111112024	Round 24in.-Typ:01-NF-Solid	24	88.00
MLV-111114028	Round 28in.-Typ:01-NF-Solid	28	105.33
MLV-111115030	Round 30in.-Typ:01-NF-Solid	30	115.00
MLV-111116032	Round 32in.-Typ:01-NF-Solid	32	125.33
MLV-111118036	Round 36in.-Typ:01-NF-Solid	36	148.00
MLV-111120040	Round 40in.-Typ:01-NF-Solid	40	173.33
MLV-111121042	Round 42in.-Typ:01-NF-Solid	42	187.00
MLV-111122044	Round 44in.-Typ:01-NF-Solid	44	201.33

CAT: MLV	HALF ROUND LOUVERS			
PRODUCT NO.	DESCRIPTION	WIDTH (in)	HEIGHT (in)	PRICE (each)
MLV-113114020	Half Round 14x20in.-Typ:01-NF-Solid	20	14	65.64
MLV-113116024	Half Round 16x24in.-Typ:01-NF-Solid	24	16	73.49
MLV-113118028	Half Round 18x28in.-Typ:01-NF-Solid	28	18	82.39
MLV-113120032	Half Round 20x32in.-Typ:01-NF-Solid	32	20	92.33
MLV-113122036	Half Round 22x36in.-Typ:01-NF-Solid	36	22	103.32
MLV-113124040	Half Round 24x40in.-Typ:01-NF-Solid	40	24	120.36
MLV-113126044	Half Round 26x44in.-Typ:01-NF-Solid	44	26	133.44
MLV-113128048	Half Round 28x48in.-Typ:01-NF-Solid	48	28	147.57
MLV-113130052	Half Round 30x52in.-Typ:01-NF-Solid	52	30	170.73
MLV-113134060	Half Round 34x60in.-Typ:01-NF-Solid	60	34	196.24
MLV-113140072	Half Round 40x72in.-Typ:01-NF-Solid	72	40	254.33

NF - Non Functional

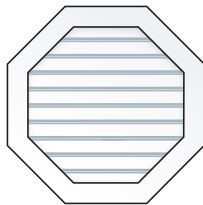

Octagon

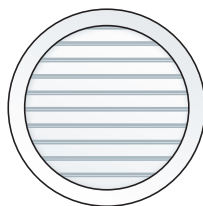

Round

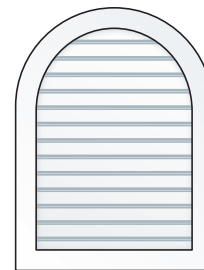

Round Top

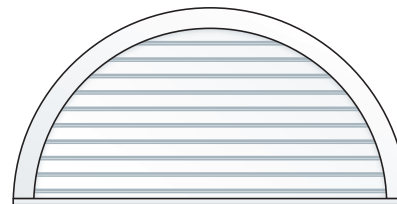

Half Round

Make the ULTIMATE First Impression in your neighbourhood!

www.valor.ca

VALOR SPECIALTY PRODUCTS INC.

1800 Courtneypark Dr. East, Units 2-4
Mississauga, ON Canada L5T 1W1

TEL: (905) 564-3122 • FAX: (905) 564-5470

PVC Louvers

3/4in PVC Sheet, Double Layered

CAT: MLV		RECTANGULAR LOUVERS		
PRODUCT NO.	DESCRIPTION	WIDTH (in)	HEIGHT (in)	PRICE (each)
MLV-114110016	Rectangular 10x16in.-Typ:01-NF-Solid	10	16	53.33
MLV-114112018	Rectangular 12x18in.-Typ:01-NF-Solid	12	18	58.00
MLV-114114022	Rectangular 14x22in.-Typ:01-NF-Solid	14	22	65.67
MLV-114116024	Rectangular 16x24in.-Typ:01-NF-Solid	16	24	72.00
MLV-114118028	Rectangular 18x28in.-Typ:01-NF-Solid	18	28	82.00
MLV-114120030	Rectangular 20x30in.-Typ:01-NF-Solid	20	30	90.00
MLV-114124036	Rectangular 24x36in.-Typ:01-NF-Solid	24	36	112.00
MLV-114130046	Rectangular 30x46in.-Typ:01-NF-Solid	30	46	155.00
MLV-114136054	Rectangular 36x54in.-Typ:01-NF-Solid	36	54	202.00
MLV-114140060	Rectangular 40x60in.-Typ:01-NF-Solid	40	60	240.00
MLV-114142064	Rectangular 42x64in.-Typ:01-NF-Solid	42	64	264.00
MLV-114312024	Rectangular 12x24in.-Typ:03 w/BrkMLD	12	24	58.70 ●
MLV-114316024	Rectangular 16x24in.-Typ:03 w/BrkMLD	16	24	66.08 ●
MLV-114316036	Rectangular 16x36in.-Typ:03 w/BrkMLD	16	36	84.55 ●
MLV-114318030	Rectangular 18x30in.-Typ:03 w/BrkMLD	18	30	69.24 ●
MLV-114324024	Rectangular 24x24in.-Typ:03 w/BrkMLD	24	24	89.24 ●
MLV-114324048	Rectangular 24x48in.-Typ:03 w/BrkMLD	24	48	160.65 ●
CAT: MLV		SQUARE LOUVERS		
MLV-115110010	Square 10in.-Typ:01-NF-Solid	10	10	48.33
MLV-115112012	Square 12in.-Typ:01-NF-Solid	12	12	52.00
MLV-115114014	Square 14in.-Typ:01-NF-Solid	14	14	56.33
MLV-115116016	Square 16in.-Typ:01-NF-Solid	16	16	61.33
MLV-115118018	Square 18in.-Typ:01-NF-Solid	18	18	67.00
MLV-115120020	Square 20in.-Typ:01-NF-Solid	20	20	73.33
MLV-115124024	Square 24in.-Typ:01-NF-Solid	24	24	88.00
MLV-115130030	Square 30in.-Typ:01-NF-Solid	30	30	115.00
MLV-115136036	Square 36in.-Typ:01-NF-Solid	36	36	148.00
MLV-115140040	Square 40in.-Typ:01-NF-Solid	40	40	173.33
MLV-115142042	Square 42in.-Typ:01-NF-Solid	42	42	187.00
CAT: MLV		OVAL LOUVERS		
MLV-116112018	Oval 12x18in.-Typ:01-NF-Solid	12	18	92.66
MLV-116114020	Oval 14x20in.-Typ:01-NF-Solid	14	20	97.90
MLV-116116024	Oval 16x24in.-Typ:01-NF-Solid	16	24	106.40
MLV-116118026	Oval 18x26in.-Typ:01-NF-Solid	18	26	134.53
MLV-116122032	Oval 22x32in.-Typ:01-NF-Solid	22	32	132.57
MLV-116128040	Oval 28x40in.-Typ:01-NF-Solid	28	40	166.58
MLV-116132048	Oval 32x48in.-Typ:01-NF-Solid	32	48	200.60

NF - Non Functional



Rectangular



Rectangular
● w/Brickmould



Square

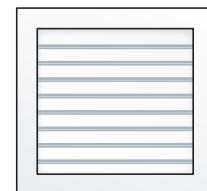

Oval

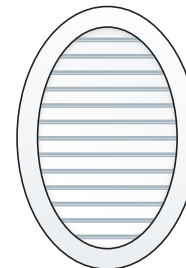

Make the **ULTIMATE** First Impression in your neighbourhood!

www.valor.ca

VALOR SPECIALTY PRODUCTS INC.

1800 Courtneypark Dr. East, Units 2-4
Mississauga, ON Canada L5T 1W1

TEL: (905) 564-3122 • FAX: (905) 564-5470

PVC Louvers

3/4in PVC Sheet, Double Layered

CAT: MLV		MODEL: MLV-1171 TRIANGULAR LOUVERS w/2.50IN FRAME (NF)														
		PITCH														
BASE(IN.):	5/12	6/12	7/12	8/12	9/12	10/12	11/12	12/12	13/12	14/12	15/12	16/12	17/12	18/12	19/12	24/12
36	7.50	9.00	10.50	12.00	13.50	15.00	16.50	18.00	19.50	21.00	22.50	24.00	25.50	27.00	28.50	36.00
PRICE:	67.50	72.00	76.50	81.00	85.50	90.00	94.50	99.00	103.50	108.00	112.50	117.00	121.50	126.00	130.50	153.00
42	8.75	10.50	12.25	14.00	15.75	17.50	19.25	21.00	22.75	24.50	26.25	28.00	29.75	31.50	33.25	42.00
PRICE:	75.63	81.75	87.88	94.00	100.13	106.25	112.38	118.50	124.63	130.75	136.88	143.00	149.13	155.25	161.38	192.00
48	10.00	12.00	14.00	16.00	18.00	20.00	22.00	24.00	26.00	28.00	30.00	32.00	34.00	36.00	38.00	48.00
PRICE:	85.00	93.00	101.00	109.00	117.00	125.00	133.00	141.00	149.00	157.00	165.00	173.00	181.00	189.00	197.00	237.00
54	11.25	13.50	15.75	18.00	20.25	22.50	24.75	27.00	29.25	31.50	33.75	36.00	38.25	40.50	42.75	54.00
PRICE:	95.63	105.75	115.88	126.00	136.13	146.25	156.38	166.50	176.63	186.75	196.88	207.00	217.13	227.25	237.38	288.00
60	12.50	15.00	17.50	20.00	22.50	25.00	27.50	30.00	32.50	35.00	37.50	40.00	42.50	45.00	47.50	60.00
PRICE:	107.50	120.00	132.50	145.00	157.50	170.00	182.50	195.00	207.50	220.00	232.50	245.00	257.50	270.00	282.50	345.00
66	13.75	16.50	19.25	22.00	24.75	27.50	30.25	33.00	35.75	38.50	41.25	44.00	46.75	49.50	52.25	66.00
PRICE:	120.63	135.75	150.88	166.00	181.13	196.25	211.38	226.50	241.63	256.75	271.88	287.00	302.13	317.25	332.38	408.00
72	15.00	18.00	21.00	24.00	27.00	30.00	33.00	36.00	39.00	42.00	45.00	48.00	51.00	54.00	57.00	72.00
PRICE:	135.00	153.00	171.00	189.00	207.00	225.00	243.00	261.00	279.00	297.00	315.00	333.00	351.00	369.00	387.00	477.00
78	16.25	19.50	22.75	26.00	29.25	32.50	35.75	39.00	42.25	45.50	48.75	52.00	55.25	58.50	61.75	78.00
PRICE:	150.63	171.75	192.88	214.00	235.13	256.25	277.38	298.50	319.63	340.75	361.88	383.00	404.13	425.25	446.38	552.00
84	17.50	21.00	24.50	28.00	31.50	35.00	38.50	42.00	45.50	49.00	52.50	56.00	59.50	63.00	66.50	84.00
PRICE:	167.50	192.00	216.50	241.00	265.50	290.00	314.50	339.00	363.50	388.00	412.50	437.00	461.50	486.00	510.50	633.00
90	18.75	22.50	26.25	30.00	33.75	37.50	41.25	45.00	48.75	52.50	56.25	60.00	63.75	67.50	71.25	90.00
PRICE:	185.63	213.75	241.88	270.00	298.13	326.25	354.38	382.50	410.63	438.75	466.88	495.00	523.13	551.25	579.38	720.00

Note: Larger size Louvers indicated within outlined area, will be produced (and may be shipped) in 2-Sections, utilizing a vertical batten to cover the joint.

CAT: MLV		TRIANGULAR LOUVERS w/o FRAME		
PRODUCT NO.	DESCRIPTION	PACKAGING (per box)	PRICE (each)	
MLV-117210053	PVC Louver Tri-Panel 22.0x52.8in 10/12P Typ:02-NF (NO FRAME)	1	142.50	
MLV-117210086	PVC Louver Tri-Panel 36.0x86.4in 10/12P Typ:02-NF (NO FRAME)	1	184.50	
MLV-117212052	PVC Louver Tri-Panel 26.0x52.0in 12/12P Typ:02-NF (NO FRAME)	1	142.75	
MLV-117212084	PVC Louver Tri-Panel 42.0x84.0in 12/12P Typ:02-NF (NO FRAME)	1	249.50	



PAINT SCH. CODE: 1C

NF - Non Functional

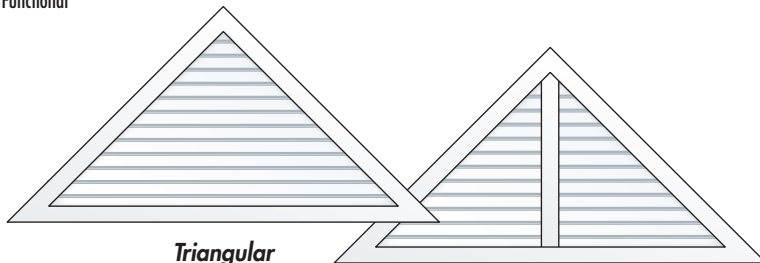

Triangular

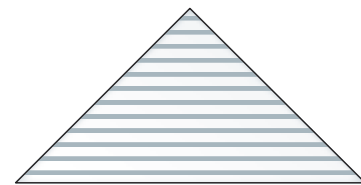

Triangular w/o Frame

Make the ULTIMATE First Impression in your neighbourhood!

www.valor.ca

VALOR SPECIALTY PRODUCTS INC.

1800 Courtneypark Dr. East, Units 2-4
Mississauga, ON Canada L5T 1W1

TEL: (905) 564-3122 • FAX: (905) 564-5470

PVC Wall Accents / Sunbursts

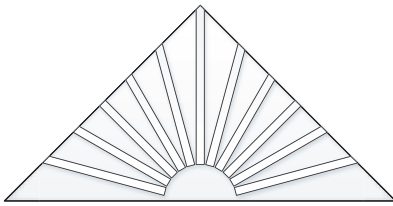

MWA-110

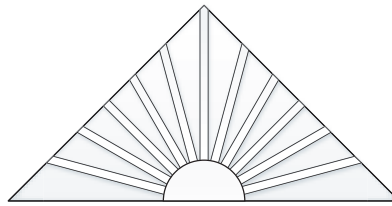

MWA-120

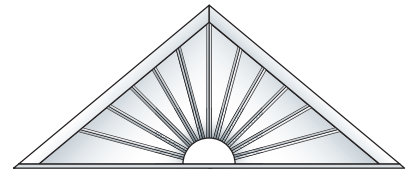

MWA-120

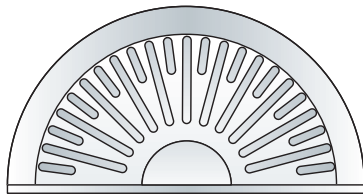

MWA-210

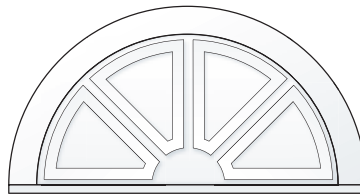

MWA-220

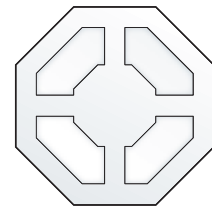

MWA-310

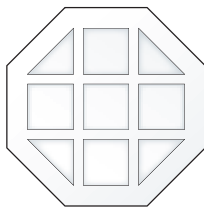

MWA-320

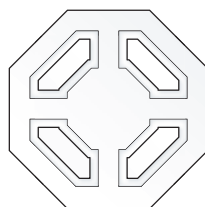

MWA-330

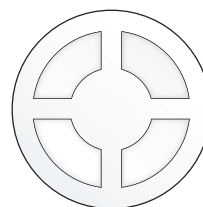

MWA-410

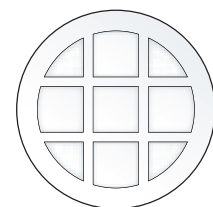

MWA-420

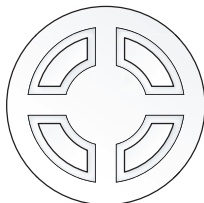

MWA-430

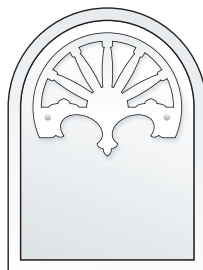

MWA-501

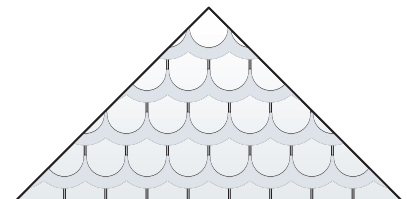

MWA-510

Make the ULTIMATE First Impression in your neighbourhood!

www.valor.ca

VALOR SPECIALTY PRODUCTS INC.

1800 Courtneypark Dr. East, Units 2-4
Mississauga, ON Canada L5T 1W1

TEL: (905) 564-3122 • FAX: (905) 564-5470

PVC Wall Accents / Sunbursts

Note: Larger size Wall Accents indicated within outlined area, will be produced (and may be shipped) in 2-Sections, utilizing a vertical batten to cover the joint.

5/8in PVC Sheet, 1-layer, Machine Recessed

CAT: MWA		MODEL: MWA-110														
		PITCH														
BASE(IN.):	5/12	6/12	7/12	8/12	9/12	10/12	11/12	12/12	13/12	14/12	15/12	16/12	17/12	18/12	19/12	20/12
36	7.50	9.00	10.50	12.00	13.50	15.00	16.50	18.00	19.50	21.00	22.50	24.00	25.50	27.00	28.50	30.00
PRICE:	59.27	61.85	64.42	67.00	69.58	72.16	74.74	77.32	79.89	82.47	85.05	87.63	90.21	92.79	95.36	108.26
48	10.00	12.00	14.00	16.00	18.00	20.00	22.00	24.00	26.00	28.00	30.00	32.00	34.00	36.00	38.00	40.00
PRICE:	69.29	73.88	78.46	83.05	87.63	92.21	96.80	101.38	105.96	110.55	115.13	119.72	124.30	128.88	133.47	156.39
60	12.50	15.00	17.50	20.00	22.50	25.00	27.50	30.00	32.50	35.00	37.50	40.00	42.50	45.00	47.50	50.00
PRICE:	82.19	89.35	96.51	103.67	110.83	118.00	125.16	132.32	139.48	146.65	153.81	160.97	168.13	175.29	182.46	218.27
72	15.00	18.00	21.00	24.00	27.00	30.00	33.00	36.00	39.00	42.00	45.00	48.00	51.00	54.00	57.00	60.00
PRICE:	97.94	108.26	118.57	128.88	139.20	149.51	159.82	170.14	180.45	190.76	201.08	211.39	221.70	232.02	242.33	293.90
84	17.50	21.00	24.50	28.00	31.50	35.00	38.50	42.00	45.50	49.00	52.50	56.00	59.50	63.00	66.50	70.00
PRICE:	116.56	130.60	144.64	158.68	172.72	186.75	200.79	214.83	228.87	242.90	256.94	270.98	285.02	299.06	313.09	383.28
96	20.00	24.00	28.00	32.00	36.00	40.00	44.00	48.00	52.00	56.00	60.00	64.00	68.00	72.00	76.00	80.00
PRICE:	138.05	156.39	174.72	193.06	211.39	229.73	248.06	266.40	284.73	303.07	321.40	339.74	358.07	376.41	394.74	486.42

5/8in PVC Sheet, 1-layer, Machine Recessed. 3/4 x 3/4in Slats Inserted, 8in Dia. Centre

CAT: MWA		MODEL: MWA-120														
		PITCH														
BASE(IN.):	5/12	6/12	7/12	8/12	9/12	10/12	11/12	12/12	13/12	14/12	15/12	16/12	17/12	18/12	19/12	20/12
36	7.50	9.00	10.50	12.00	13.50	15.00	16.50	18.00	19.50	21.00	22.50	24.00	25.50	27.00	28.50	30.00
PRICE:	86.47	90.30	94.13	97.95	101.78	105.61	109.44	113.27	117.10	120.93	124.76	128.59	132.41	136.24	140.07	159.22
48	10.00	12.00	14.00	16.00	18.00	20.00	22.00	24.00	26.00	28.00	30.00	32.00	34.00	36.00	38.00	40.00
PRICE:	101.36	108.17	114.97	121.78	128.59	135.39	142.20	149.01	155.81	162.62	169.43	176.23	183.04	189.85	196.66	230.69
60	12.50	15.00	17.50	20.00	22.50	25.00	27.50	30.00	32.50	35.00	37.50	40.00	42.50	45.00	47.50	50.00
PRICE:	120.50	131.14	141.77	152.41	163.05	173.68	184.32	194.95	205.59	216.23	226.86	237.50	248.13	258.77	269.40	322.58
72	15.00	18.00	21.00	24.00	27.00	30.00	33.00	36.00	39.00	42.00	45.00	48.00	51.00	54.00	57.00	60.00
PRICE:	143.90	159.22	174.53	189.85	205.16	220.48	235.79	251.11	266.43	281.74	297.06	312.37	327.69	343.00	358.32	434.90
84	17.50	21.00	24.50	28.00	31.50	35.00	38.50	42.00	45.50	49.00	52.50	56.00	59.50	63.00	66.50	70.00
PRICE:	171.55	192.40	213.25	234.09	254.94	275.79	296.63	317.48	338.32	359.17	380.02	400.86	421.71	442.55	463.40	567.63
96	20.00	24.00	28.00	32.00	36.00	40.00	44.00	48.00	52.00	56.00	60.00	64.00	68.00	72.00	76.00	80.00
PRICE:	203.46	230.69	257.92	285.15	312.37	339.60	366.83	394.06	421.28	448.51	475.74	502.97	530.19	557.42	584.65	720.79

5/8in PVC Sheet, 1-layer, Machine Recessed. 3/4 x 3/4in Slats Inserted, 8in Dia. Centre

CAT: MWA		MODEL: MWA-130														
		PITCH														
BASE(IN.):	5/12	6/12	7/12	8/12	9/12	10/12	11/12	12/12	13/12	14/12	15/12	16/12	17/12	18/12	19/12	20/12
36	7.50	9.00	10.50	12.00	13.50	15.00	16.50	18.00	19.50	21.00	22.50	24.00	25.50	27.00	28.50	30.00
PRICE:	96.43	100.70	104.97	109.23	113.51	117.78	122.05	126.32	130.59	134.86	139.13	143.40	147.66	151.93	156.21	177.56
48	10.00	12.00	14.00	16.00	18.00	20.00	22.00	24.00	26.00	28.00	30.00	32.00	34.00	36.00	38.00	40.00
PRICE:	113.04	120.63	128.21	135.81	143.40	150.99	158.58	166.18	173.76	181.35	188.95	196.53	204.13	211.72	219.32	257.27
60	12.50	15.00	17.50	20.00	22.50	25.00	27.50	30.00	32.50	35.00	37.50	40.00	42.50	45.00	47.50	50.00
PRICE:	134.38	146.25	158.10	169.97	181.83	193.69	205.55	217.41	229.27	241.14	252.99	264.86	276.71	288.58	300.43	359.74
72	15.00	18.00	21.00	24.00	27.00	30.00	33.00	36.00	39.00	42.00	45.00	48.00	51.00	54.00	57.00	60.00
PRICE:	160.48	177.56	194.64	211.72	228.79	245.88	262.95	280.04	297.12	314.20	331.28	348.36	365.44	382.51	399.60	485.00
84	17.50	21.00	24.50	28.00	31.50	35.00	38.50	42.00	45.50	49.00	52.50	56.00	59.50	63.00	66.50	70.00
PRICE:	191.31	214.56	237.82	261.06	284.31	307.56	330.80	354.05	377.29	400.55	423.80	447.04	470.29	493.53	516.78	633.02
96	20.00	24.00	28.00	32.00	36.00	40.00	44.00	48.00	52.00	56.00	60.00	64.00	68.00	72.00	76.00	80.00
PRICE:	226.90	257.27	287.63	318.00	348.36	378.72	409.09	439.46	469.81	500.18	530.55	560.91	591.27	621.63	652.00	803.83

PVC Wall Accents / Sunbursts

2-Layers 3/4in PVC: 3/4in Mach.base, 3/4 x 2in Frame Face mount. 3/4in Sill

CAT: MWA		MODEL: MWA-210									
PITCH											
BASE(IN.):	24	28	32	36	40	44	48	54	60	72	84
HEIGHT(IN.):	12.75	14.75	16.75	18.75	20.75	22.75	24.75	27.75	30.75	36.75	42.75
PRICE:	95.69	106.28	118.28	131.69	146.51	162.74	180.39	209.51	241.80	315.91	402.72

CAT: MWA		MODEL: MWA-220									
PITCH											
BASE(IN.):	24	28	32	36	40	44	48	54	60	72	84
HEIGHT(IN.):	12.75	14.75	16.75	18.75	20.75	22.75	24.75	27.75	30.75	36.75	42.75
PRICE:	92.87	103.46	115.46	128.87	143.69	159.92	177.57	206.68	238.97	313.08	399.90

5/8in & 3/8in PVC Laminated Sheet

CAT: MWA		MODEL: MWA-310				
WIDTH / HEIGHT						
24.00IN	28.00IN	32.00IN	36.00IN	40.00IN	44.00IN	
147.33	181.58	221.09	265.87	315.92	371.24	

5/8in & 3/8in PVC Laminated Sheet

CAT: MWA		MODEL: MWA-410				
WIDTH / HEIGHT						
24.00IN	28.00IN	32.00IN	36.00IN	40.00IN	44.00IN	
147.33	181.58	221.09	265.87	315.92	371.24	

5/8in & 3/8in PVC Laminated Sheet

CAT: MWA		MODEL: MWA-320				
WIDTH / HEIGHT						
24.00IN	28.00IN	32.00IN	36.00IN	40.00IN	44.00IN	
156.08	190.33	229.84	274.62	324.67	379.99	

5/8in & 3/8in PVC Laminated Sheet

CAT: MWA		MODEL: MWA-420				
WIDTH / HEIGHT						
24.00IN	28.00IN	32.00IN	36.00IN	40.00IN	44.00IN	
156.08	190.33	229.84	274.62	324.67	379.99	

3/4in PVC Sheet, All flush, No layered material

CAT: MWA		MODEL: MWA-330				
WIDTH / HEIGHT						
24.00IN	28.00IN	32.00IN	36.00IN	40.00IN	44.00IN	
134.71	167.56	205.46	248.41	296.42	349.48	

3/4in PVC Sheet, All flush, No layered material

CAT: MWA		MODEL: MWA-430				
WIDTH / HEIGHT						
24.00IN	28.00IN	32.00IN	36.00IN	40.00IN	44.00IN	
134.71	167.56	205.46	248.41	296.42	349.48	

3/4in PVC Sheet, All flush, No layered material

CAT: MWA		MODEL: MWA-510		
PRODUCT NO.	DESCRIPTION	PACKAGING (per box)	PRICE (each)	
MWA-510110053	Wall Acc-PVC Tri-Scal. Shake 22.0x52.8in 10/12P (NO FRAME)	1	142.50	
MWA-510110086	Wall Acc-PVC Tri-Scal. Shake 36.0x86.4in 10/12P (NO FRAME)	1	275.67	
MWA-510112052	Wall Acc-PVC Tri-Scal. Shake 26.0x52.0in 12/12P (NO FRAME)	1	142.75	
MWA-510112084	Wall Acc-PVC Tri-Scal. Shake 42.0x84.0in 12/12P (NO FRAME)	1	331.55	



Make the ULTIMATE First Impression in your neighbourhood!

www.valor.ca

VALOR SPECIALTY PRODUCTS INC.

1800 Courtneypark Dr. East, Units 2-4
Mississauga, ON Canada L5T 1W1

TEL: (905) 564-3122 • FAX: (905) 564-5470

VALOR

SPECIALTY PRODUCTS INC.

PVC Headers



PVC Header - Rake



Keystone



PVC Header - Rake with Bullnose

CAT: MHR
PVC HEADER 5.50" HEIGHT TYPE: MHR-1011 (3/4" BOARD W/RAKE, SQR EDGE)

PRODUCT NO.	DESCRIPTION	PACKAGING (per box)	PRICE (each)
MHR-101106024	PVC Header-Rake 5.50x24.00in	1	45.91
MHR-101106030	PVC Header-Rake 5.50x30.00in	1	50.19
MHR-101106036	PVC Header-Rake 5.50x36.00in	1	54.46
MHR-101106042	PVC Header-Rake 5.50x42.00in	1	58.73
MHR-101106048	PVC Header-Rake 5.50x48.00in	1	63.01
MHR-101106054	PVC Header-Rake 5.50x54.00in	1	67.28
MHR-101106060	PVC Header-Rake 5.50x60.00in	1	71.56
MHR-101106066	PVC Header-Rake 5.50x66.00in	1	75.83
MHR-101106072	PVC Header-Rake 5.50x72.00in	1	80.10
MHR-101106078	PVC Header-Rake 5.50x78.00in	1	84.38
MHR-101106084	PVC Header-Rake 5.50x84.00in	1	88.65
MHR-101106096	PVC Header-Rake 5.50x96.00in	1	97.20
MHR-101106108	PVC Header-Rake 5.50x108.00in	1	105.74
MHR-101106120	PVC Header-Rake 5.50x120.00in	1	114.29
MHR-101106144	PVC Header-Rake 5.50x144.00in	1	131.38
MHR-101106000	PVC Header-Rake Custom Size	1	Quote
MHR-101106010	PVC Header-Rake 5.50in KEYSTONE-Typ:01	1	19.25

CAT: MHR
PVC HEADER 7.25" HEIGHT TYPE: MHR-1011 (3/4" BOARD W/RAKE, SQR EDGE)

PRODUCT NO.	DESCRIPTION	PACKAGING (per box)	PRICE (each)
MHR-101108024	PVC Header-Rake 7.25x24.00in	1	49.43
MHR-101108030	PVC Header-Rake 7.25x30.00in	1	54.58
MHR-101108036	PVC Header-Rake 7.25x36.00in	1	59.73
MHR-101108042	PVC Header-Rake 7.25x42.00in	1	64.88
MHR-101108048	PVC Header-Rake 7.25x48.00in	1	70.03
MHR-101108054	PVC Header-Rake 7.25x54.00in	1	75.18
MHR-101108060	PVC Header-Rake 7.25x60.00in	1	80.33
MHR-101108066	PVC Header-Rake 7.25x66.00in	1	85.48
MHR-101108072	PVC Header-Rake 7.25x72.00in	1	90.64
MHR-101108078	PVC Header-Rake 7.25x78.00in	1	95.79
MHR-101108084	PVC Header-Rake 7.25x84.00in	1	100.94
MHR-101108096	PVC Header-Rake 7.25x96.00in	1	111.24
MHR-101108108	PVC Header-Rake 7.25x108.00in	1	121.54
MHR-101108120	PVC Header-Rake 7.25x120.00in	1	131.85
MHR-101108144	PVC Header-Rake 7.25x144.00in	1	152.45
MHR-101108000	PVC Header-Rake Custom Size	1	Quote
MHR-101108010	PVC Header-Rake 7.25in KEYSTONE-Typ:01	1	25.38

CAT: MHR
PVC HEADER 5.50" HEIGHT TYPE: MHR-1012 (3/4" BOARD W/RAKE, BULLNOSE EDGE)

PRODUCT NO.	DESCRIPTION	PACKAGING (per box)	PRICE (each)
MHR-101206024	PVC Header-Rake (BNS) 5.50x24.00in	1	48.31
MHR-101206030	PVC Header-Rake (BNS) 5.50x30.00in	1	53.19
MHR-101206036	PVC Header-Rake (BNS) 5.50x36.00in	1	58.05
MHR-101206042	PVC Header-Rake (BNS) 5.50x42.00in	1	62.92
MHR-101206048	PVC Header-Rake (BNS) 5.50x48.00in	1	67.80
MHR-101206054	PVC Header-Rake (BNS) 5.50x54.00in	1	72.67
MHR-101206060	PVC Header-Rake (BNS) 5.50x60.00in	1	77.54
MHR-101206066	PVC Header-Rake (BNS) 5.50x66.00in	1	82.41
MHR-101206072	PVC Header-Rake (BNS) 5.50x72.00in	1	87.28
MHR-101206078	PVC Header-Rake (BNS) 5.50x78.00in	1	92.16
MHR-101206084	PVC Header-Rake (BNS) 5.50x84.00in	1	97.03
MHR-101206096	PVC Header-Rake (BNS) 5.50x96.00in	1	106.77
MHR-101206108	PVC Header-Rake (BNS) 5.50x108.00in	1	116.52
MHR-101206120	PVC Header-Rake (BNS) 5.50x120.00in	1	126.26
MHR-101206144	PVC Header-Rake (BNS) 5.50x144.00in	1	145.75
MHR-101206000	PVC Header-Rake (BNS) Custom Size	1	Quote
MHR-101106010	PVC Header-Rake 5.50in KEYSTONE-Typ:01	1	19.25

CAT: MHR
PVC HEADER 7.25" HEIGHT TYPE: MHR-1012 (3/4" BOARD W/RAKE, BULLNOSE EDGE)

PRODUCT NO.	DESCRIPTION	PACKAGING (per box)	PRICE (each)
MHR-101208024	PVC Header-Rake (BNS) 7.25x24.00in	1	52.62
MHR-101208030	PVC Header-Rake (BNS) 7.25x30.00in	1	58.57
MHR-101208036	PVC Header-Rake (BNS) 7.25x36.00in	1	64.52
MHR-101208042	PVC Header-Rake (BNS) 7.25x42.00in	1	70.47
MHR-101208048	PVC Header-Rake (BNS) 7.25x48.00in	1	76.41
MHR-101208054	PVC Header-Rake (BNS) 7.25x54.00in	1	82.36
MHR-101208060	PVC Header-Rake (BNS) 7.25x60.00in	1	88.31
MHR-101208066	PVC Header-Rake (BNS) 7.25x66.00in	1	94.26
MHR-101208072	PVC Header-Rake (BNS) 7.25x72.00in	1	100.21
MHR-101208078	PVC Header-Rake (BNS) 7.25x78.00in	1	106.16
MHR-101208084	PVC Header-Rake (BNS) 7.25x84.00in	1	112.11
MHR-101208096	PVC Header-Rake (BNS) 7.25x96.00in	1	124.01
MHR-101208108	PVC Header-Rake (BNS) 7.25x108.00in	1	135.91
MHR-101208120	PVC Header-Rake (BNS) 7.25x120.00in	1	147.81
MHR-101208144	PVC Header-Rake (BNS) 7.25x144.00in	1	171.60
MHR-101208000	PVC Header-Rake (BNS) Custom Size	1	Quote
MHR-101108010	PVC Header-Rake 7.25in KEYSTONE-Typ:01	1	25.38

For Custom Lengths specify length to the 1/4in and use the next largest size for price.
Optional Keystone: Same for SQR or BNS Edge

BNS - Bullnose

VALOR

SPECIALTY PRODUCTS INC.

PVC Headers



PVC Header - Crown Mould



Keystone



PVC Header - Crown Mould with Bullnose

CAT: MHR PVC HEADER 5.50" HEIGHT TYPE: MHR-1021 (3/4" BOARD W/3.5"CROWN, SQR EDGE)			
PRODUCT NO.	DESCRIPTION	PACKAGING (per box)	PRICE (each)
MHR-102106024	PVC Header-3.5 Crown 5.50x24.00in	1	60.93
MHR-102106030	PVC Header-3.5 Crown 5.50x30.00in	1	68.69
MHR-102106036	PVC Header-3.5 Crown 5.50x36.00in	1	76.45
MHR-102106042	PVC Header-3.5 Crown 5.50x42.00in	1	84.21
MHR-102106048	PVC Header-3.5 Crown 5.50x48.00in	1	91.96
MHR-102106054	PVC Header-3.5 Crown 5.50x54.00in	1	99.72
MHR-102106060	PVC Header-3.5 Crown 5.50x60.00in	1	107.48
MHR-102106066	PVC Header-3.5 Crown 5.50x66.00in	1	115.24
MHR-102106072	PVC Header-3.5 Crown 5.50x72.00in	1	122.99
MHR-102106078	PVC Header-3.5 Crown 5.50x78.00in	1	130.75
MHR-102106084	PVC Header-3.5 Crown 5.50x84.00in	1	138.51
MHR-102106096	PVC Header-3.5 Crown 5.50x96.00in	1	154.02
MHR-102106108	PVC Header-3.5 Crown 5.50x108.00in	1	169.54
MHR-102106120	PVC Header-3.5 Crown 5.50x120.00in	1	185.05
MHR-102106144	PVC Header-3.5 Crown 5.50x144.00in	1	216.08
MHR-102106000	PVC Header-3.5 Crown Custom Size	1	Quote
MHR-102106010	PVC Header-3.5 Crown 5.50in KEYSTONE-Typ:01	1	19.25

CAT: MHR PVC HEADER 7.25" HEIGHT TYPE: MHR-1021 (3/4" BOARD W/3.5"CROWN, SQR EDGE)			
PRODUCT NO.	DESCRIPTION	PACKAGING (per box)	PRICE (each)
MHR-102108024	PVC Header-3.5 Crown 7.25x24.00in	1	64.44
MHR-102108030	PVC Header-3.5 Crown 7.25x30.00in	1	73.08
MHR-102108036	PVC Header-3.5 Crown 7.25x36.00in	1	81.72
MHR-102108042	PVC Header-3.5 Crown 7.25x42.00in	1	90.35
MHR-102108048	PVC Header-3.5 Crown 7.25x48.00in	1	98.99
MHR-102108054	PVC Header-3.5 Crown 7.25x54.00in	1	107.62
MHR-102108060	PVC Header-3.5 Crown 7.25x60.00in	1	116.26
MHR-102108066	PVC Header-3.5 Crown 7.25x66.00in	1	124.89
MHR-102108072	PVC Header-3.5 Crown 7.25x72.00in	1	133.53
MHR-102108078	PVC Header-3.5 Crown 7.25x78.00in	1	142.16
MHR-102108084	PVC Header-3.5 Crown 7.25x84.00in	1	150.80
MHR-102108096	PVC Header-3.5 Crown 7.25x96.00in	1	168.07
MHR-102108108	PVC Header-3.5 Crown 7.25x108.00in	1	185.34
MHR-102108120	PVC Header-3.5 Crown 7.25x120.00in	1	202.61
MHR-102108144	PVC Header-3.5 Crown 7.25x144.00in	1	237.15
MHR-102108000	PVC Header-3.5 Crown Custom Size	1	Quote
MHR-102108010	PVC Header-3.5 Crown 7.25in KEYSTONE-Typ:01	1	25.38

CAT: MHR PVC HEADER 5.50" HEIGHT TYPE: MHR-1022 (3/4" BOARD W/3.5"CROWN, BULLNOSE EDGE)			
PRODUCT NO.	DESCRIPTION	PACKAGING (per box)	PRICE (each)
MHR-102206024	PVC Header-3.5 Crown (BNS) 5.50x24.00in	1	63.33
MHR-102206030	PVC Header-3.5 Crown (BNS) 5.50x30.00in	1	71.68
MHR-102206036	PVC Header-3.5 Crown (BNS) 5.50x36.00in	1	80.04
MHR-102206042	PVC Header-3.5 Crown (BNS) 5.50x42.00in	1	88.40
MHR-102206048	PVC Header-3.5 Crown (BNS) 5.50x48.00in	1	96.75
MHR-102206054	PVC Header-3.5 Crown (BNS) 5.50x54.00in	1	105.11
MHR-102206060	PVC Header-3.5 Crown (BNS) 5.50x60.00in	1	113.46
MHR-102206066	PVC Header-3.5 Crown (BNS) 5.50x66.00in	1	121.82
MHR-102206072	PVC Header-3.5 Crown (BNS) 5.50x72.00in	1	130.17
MHR-102206078	PVC Header-3.5 Crown (BNS) 5.50x78.00in	1	138.53
MHR-102206084	PVC Header-3.5 Crown (BNS) 5.50x84.00in	1	146.89
MHR-102206096	PVC Header-3.5 Crown (BNS) 5.50x96.00in	1	163.60
MHR-102206108	PVC Header-3.5 Crown (BNS) 5.50x108.00in	1	180.31
MHR-102206120	PVC Header-3.5 Crown (BNS) 5.50x120.00in	1	197.02
MHR-102206144	PVC Header-3.5 Crown (BNS) 5.50x144.00in	1	230.45
MHR-102206000	PVC Header-3.5 Crown (BNS) Custom Size	1	Quote
MHR-102106010	PVC Header-3.5 Crown 5.50in KEYSTONE-Typ:01	1	19.25

CAT: MHR PVC HEADER 7.25" HEIGHT TYPE: MHR-1022 (3/4" BOARD W/3.5"CROWN, BULLNOSE EDGE)			
PRODUCT NO.	DESCRIPTION	PACKAGING (per box)	PRICE (each)
MHR-102208024	PVC Header-3.5 Crown (BNS) 7.25x24.00in	1	67.64
MHR-102208030	PVC Header-3.5 Crown (BNS) 7.25x30.00in	1	77.07
MHR-102208036	PVC Header-3.5 Crown (BNS) 7.25x36.00in	1	86.50
MHR-102208042	PVC Header-3.5 Crown (BNS) 7.25x42.00in	1	95.94
MHR-102208048	PVC Header-3.5 Crown (BNS) 7.25x48.00in	1	105.37
MHR-102208054	PVC Header-3.5 Crown (BNS) 7.25x54.00in	1	114.80
MHR-102208060	PVC Header-3.5 Crown (BNS) 7.25x60.00in	1	124.24
MHR-102208066	PVC Header-3.5 Crown (BNS) 7.25x66.00in	1	133.67
MHR-102208072	PVC Header-3.5 Crown (BNS) 7.25x72.00in	1	143.10
MHR-102208078	PVC Header-3.5 Crown (BNS) 7.25x78.00in	1	152.54
MHR-102208084	PVC Header-3.5 Crown (BNS) 7.25x84.00in	1	161.97
MHR-102208096	PVC Header-3.5 Crown (BNS) 7.25x96.00in	1	180.84
MHR-102208108	PVC Header-3.5 Crown (BNS) 7.25x108.00in	1	199.70
MHR-102208120	PVC Header-3.5 Crown (BNS) 7.25x120.00in	1	218.57
MHR-102208144	PVC Header-3.5 Crown (BNS) 7.25x144.00in	1	256.30
MHR-102208000	PVC Header-3.5 Crown (BNS) Custom Size	1	Quote
MHR-102108010	PVC Header-3.5 Crown 7.25in KEYSTONE-Typ:01	1	25.38

For Custom Lengths specify length to the 1/4in and use the next largest size for price.
Optional Keystone: Same for SQR or BNS Edge

BNS - Bullnose

VALOR

SPECIALTY PRODUCTS INC.

PVC Headers



PVC Header - Rams Crown Mould



Keystone



PVC Header - Rams Crown Mould with Bullnose

CAT: MHR
PVC HEADER 5.50" HEIGHT TYPE: MHR-1031 (3/4" BOARD W/RAMS CROWN, SQR EDGE)

PRODUCT NO.	DESCRIPTION	PACKAGING (per box)	PRICE (each)
MHR-103106024	PVC Header-Rams Crown 5.50x24.00in	1	49.97
MHR-103106030	PVC Header-Rams Crown 5.50x30.00in	1	55.14
MHR-103106036	PVC Header-Rams Crown 5.50x36.00in	1	60.32
MHR-103106042	PVC Header-Rams Crown 5.50x42.00in	1	65.49
MHR-103106048	PVC Header-Rams Crown 5.50x48.00in	1	70.67
MHR-103106054	PVC Header-Rams Crown 5.50x54.00in	1	75.84
MHR-103106060	PVC Header-Rams Crown 5.50x60.00in	1	81.01
MHR-103106066	PVC Header-Rams Crown 5.50x66.00in	1	86.19
MHR-103106072	PVC Header-Rams Crown 5.50x72.00in	1	91.36
MHR-103106078	PVC Header-Rams Crown 5.50x78.00in	1	96.54
MHR-103106084	PVC Header-Rams Crown 5.50x84.00in	1	101.71
MHR-103106096	PVC Header-Rams Crown 5.50x96.00in	1	112.06
MHR-103106108	PVC Header-Rams Crown 5.50x108.00in	1	122.41
MHR-103106120	PVC Header-Rams Crown 5.50x120.00in	1	132.76
MHR-103106144	PVC Header-Rams Crown 5.50x144.00in	1	153.46
MHR-103106000	PVC Header-Rams Crown Custom Size	1	Quote
MHR-103106010	PVC Header-Rams Crown 5.50in KEYSTONE-Typ:01	1	19.25

CAT: MHR
PVC HEADER 7.25" HEIGHT TYPE: MHR-1031 (3/4" BOARD W/RAMS CROWN, SQR EDGE)

MHR-103108024	PVC Header-Rams Crown 7.25x24.00in	1	53.48
MHR-103108030	PVC Header-Rams Crown 7.25x30.00in	1	59.53
MHR-103108036	PVC Header-Rams Crown 7.25x36.00in	1	65.58
MHR-103108042	PVC Header-Rams Crown 7.25x42.00in	1	71.64
MHR-103108048	PVC Header-Rams Crown 7.25x48.00in	1	77.69
MHR-103108054	PVC Header-Rams Crown 7.25x54.00in	1	83.74
MHR-103108060	PVC Header-Rams Crown 7.25x60.00in	1	89.79
MHR-103108066	PVC Header-Rams Crown 7.25x66.00in	1	95.84
MHR-103108072	PVC Header-Rams Crown 7.25x72.00in	1	101.90
MHR-103108078	PVC Header-Rams Crown 7.25x78.00in	1	107.95
MHR-103108084	PVC Header-Rams Crown 7.25x84.00in	1	114.00
MHR-103108096	PVC Header-Rams Crown 7.25x96.00in	1	126.11
MHR-103108108	PVC Header-Rams Crown 7.25x108.00in	1	138.21
MHR-103108120	PVC Header-Rams Crown 7.25x120.00in	1	150.31
MHR-103108144	PVC Header-Rams Crown 7.25x144.00in	1	174.52
MHR-103108000	PVC Header-Rams Crown Custom Size	1	Quote
MHR-103108010	PVC Header-Rams Crown 7.25in KEYSTONE-Typ:01	1	25.38

CAT: MHR
PVC HEADER 5.50" HEIGHT TYPE: MHR-1032 (3/4" BOARD W/RAMS CROWN, BULLNOSE EDGE)

PRODUCT NO.	DESCRIPTION	PACKAGING (per box)	PRICE (each)
MHR-103206024	PVC Header-Rams Crown (BNS) 5.50x24.00in	1	52.36
MHR-103206030	PVC Header-Rams Crown (BNS) 5.50x30.00in	1	58.14
MHR-103206036	PVC Header-Rams Crown (BNS) 5.50x36.00in	1	63.91
MHR-103206042	PVC Header-Rams Crown (BNS) 5.50x42.00in	1	69.68
MHR-103206048	PVC Header-Rams Crown (BNS) 5.50x48.00in	1	75.45
MHR-103206054	PVC Header-Rams Crown (BNS) 5.50x54.00in	1	81.23
MHR-103206060	PVC Header-Rams Crown (BNS) 5.50x60.00in	1	87.00
MHR-103206066	PVC Header-Rams Crown (BNS) 5.50x66.00in	1	92.77
MHR-103206072	PVC Header-Rams Crown (BNS) 5.50x72.00in	1	98.55
MHR-103206078	PVC Header-Rams Crown (BNS) 5.50x78.00in	1	104.32
MHR-103206084	PVC Header-Rams Crown (BNS) 5.50x84.00in	1	110.09
MHR-103206096	PVC Header-Rams Crown (BNS) 5.50x96.00in	1	121.64
MHR-103206108	PVC Header-Rams Crown (BNS) 5.50x108.00in	1	133.18
MHR-103206120	PVC Header-Rams Crown (BNS) 5.50x120.00in	1	144.73
MHR-103206144	PVC Header-Rams Crown (BNS) 5.50x144.00in	1	167.82
MHR-103206000	PVC Header-Rams Crown (BNS) Custom Size	1	Quote
MHR-103106010	PVC Header-Rams Crown 5.50in KEYSTONE-Typ:01	1	19.25

CAT: MHR
PVC HEADER 7.25" HEIGHT TYPE: MHR-1032 (3/4" BOARD W/RAMS CROWN, BULLNOSE EDGE)

MHR-103208024	PVC Header-Rams Crown (BNS) 7.25x24.00in	1	56.67
MHR-103208030	PVC Header-Rams Crown (BNS) 7.25x30.00in	1	63.52
MHR-103208036	PVC Header-Rams Crown (BNS) 7.25x36.00in	1	70.37
MHR-103208042	PVC Header-Rams Crown (BNS) 7.25x42.00in	1	77.22
MHR-103208048	PVC Header-Rams Crown (BNS) 7.25x48.00in	1	84.07
MHR-103208054	PVC Header-Rams Crown (BNS) 7.25x54.00in	1	90.92
MHR-103208060	PVC Header-Rams Crown (BNS) 7.25x60.00in	1	97.77
MHR-103208066	PVC Header-Rams Crown (BNS) 7.25x66.00in	1	104.62
MHR-103208072	PVC Header-Rams Crown (BNS) 7.25x72.00in	1	111.47
MHR-103208078	PVC Header-Rams Crown (BNS) 7.25x78.00in	1	118.32
MHR-103208084	PVC Header-Rams Crown (BNS) 7.25x84.00in	1	125.17
MHR-103208096	PVC Header-Rams Crown (BNS) 7.25x96.00in	1	138.87
MHR-103208108	PVC Header-Rams Crown (BNS) 7.25x108.00in	1	152.57
MHR-103208120	PVC Header-Rams Crown (BNS) 7.25x120.00in	1	166.27
MHR-103208144	PVC Header-Rams Crown (BNS) 7.25x144.00in	1	193.68
MHR-103208000	PVC Header-Rams Crown (BNS) Custom Size	1	Quote
MHR-103108010	PVC Header-Rams Crown 7.25in KEYSTONE-Typ:01	1	25.38

For Custom Lengths specify length to the 1/4in and use the next largest size for price.
Optional Keystone: Same for SQR or BNS Edge

BNS - Bullnose

VALOR

SPECIALTY PRODUCTS INC.

PVC Headers



PVC Header - Smooth Crown Mould



Keystone



PVC Header - Smooth Crown Mould with Bullnose

CAT: MHR
PVC HEADER 5.50" HEIGHT TYPE: MHR-1041 (3/4" BOARD W/SMOOTH CROWN, SQR EDGE)

PRODUCT NO.	DESCRIPTION	PACKAGING (per box)	PRICE (each)
MHR-104106024	PVC Header-Smooth Crown 5.50x24.00in	1	65.09
MHR-104106030	PVC Header-Smooth Crown 5.50x30.00in	1	73.77
MHR-104106036	PVC Header-Smooth Crown 5.50x36.00in	1	82.45
MHR-104106042	PVC Header-Smooth Crown 5.50x42.00in	1	91.14
MHR-104106048	PVC Header-Smooth Crown 5.50x48.00in	1	99.82
MHR-104106054	PVC Header-Smooth Crown 5.50x54.00in	1	108.50
MHR-104106060	PVC Header-Smooth Crown 5.50x60.00in	1	117.18
MHR-104106066	PVC Header-Smooth Crown 5.50x66.00in	1	125.86
MHR-104106072	PVC Header-Smooth Crown 5.50x72.00in	1	134.22
MHR-104106078	PVC Header-Smooth Crown 5.50x78.00in	1	143.22
MHR-104106084	PVC Header-Smooth Crown 5.50x84.00in	1	151.91
MHR-104106096	PVC Header-Smooth Crown 5.50x96.00in	1	169.27
MHR-104106108	PVC Header-Smooth Crown 5.50x108.00in	1	186.63
MHR-104106120	PVC Header-Smooth Crown 5.50x120.00in	1	203.99
MHR-104106144	PVC Header-Smooth Crown 5.50x144.00in	1	238.72
MHR-104106000	PVC Header-Smooth Crown Custom Size	1	Quote
MHR-104106010	PVC Header-Smooth Crown 5.50in KEYSTONE-Typ:01	1	19.25

CAT: MHR
PVC HEADER 7.25" HEIGHT TYPE: MHR-1041 (3/4" BOARD W/SMOOTH CROWN, SQR EDGE)

PRODUCT NO.	DESCRIPTION	PACKAGING (per box)	PRICE (each)
MHR-104108024	PVC Header-Smooth Crown 7.25x24.00in	1	68.80
MHR-104108030	PVC Header-Smooth Crown 7.25x30.00in	1	78.16
MHR-104108036	PVC Header-Smooth Crown 7.25x36.00in	1	87.72
MHR-104108042	PVC Header-Smooth Crown 7.25x42.00in	1	97.28
MHR-104108048	PVC Header-Smooth Crown 7.25x48.00in	1	106.84
MHR-104108054	PVC Header-Smooth Crown 7.25x54.00in	1	116.40
MHR-104108060	PVC Header-Smooth Crown 7.25x60.00in	1	125.96
MHR-104108066	PVC Header-Smooth Crown 7.25x66.00in	1	135.52
MHR-104108072	PVC Header-Smooth Crown 7.25x72.00in	1	145.08
MHR-104108078	PVC Header-Smooth Crown 7.25x78.00in	1	154.64
MHR-104108084	PVC Header-Smooth Crown 7.25x84.00in	1	164.19
MHR-104108096	PVC Header-Smooth Crown 7.25x96.00in	1	183.31
MHR-104108108	PVC Header-Smooth Crown 7.25x108.00in	1	202.43
MHR-104108120	PVC Header-Smooth Crown 7.25x120.00in	1	221.55
MHR-104108144	PVC Header-Smooth Crown 7.25x144.00in	1	259.79
MHR-104108000	PVC Header-Smooth Crown Custom Size	1	Quote
MHR-104108010	PVC Header-Smooth Crown 7.25in KEYSTONE-Typ:01	1	25.38

CAT: MHR
PVC HEADER 5.50" HEIGHT TYPE: MHR-1042 (3/4" BOARD W/SMOOTH CROWN, BULLNOSE EDGE)

PRODUCT NO.	DESCRIPTION	PACKAGING (per box)	PRICE (each)
MHR-104206024	PVC Header-Smooth Crown (BNS) 5.50x24.00in	1	67.49
MHR-104206030	PVC Header-Smooth Crown (BNS) 5.50x30.00in	1	76.77
MHR-104206036	PVC Header-Smooth Crown (BNS) 5.50x36.00in	1	86.05
MHR-104206042	PVC Header-Smooth Crown (BNS) 5.50x42.00in	1	95.33
MHR-104206048	PVC Header-Smooth Crown (BNS) 5.50x48.00in	1	104.61
MHR-104206054	PVC Header-Smooth Crown (BNS) 5.50x54.00in	1	113.89
MHR-104206060	PVC Header-Smooth Crown (BNS) 5.50x60.00in	1	123.17
MHR-104206066	PVC Header-Smooth Crown (BNS) 5.50x66.00in	1	132.44
MHR-104206072	PVC Header-Smooth Crown (BNS) 5.50x72.00in	1	141.72
MHR-104206078	PVC Header-Smooth Crown (BNS) 5.50x78.00in	1	151.00
MHR-104206084	PVC Header-Smooth Crown (BNS) 5.50x84.00in	1	160.28
MHR-104206096	PVC Header-Smooth Crown (BNS) 5.50x96.00in	1	178.84
MHR-104206108	PVC Header-Smooth Crown (BNS) 5.50x108.00in	1	197.40
MHR-104206120	PVC Header-Smooth Crown (BNS) 5.50x120.00in	1	215.96
MHR-104206144	PVC Header-Smooth Crown (BNS) 5.50x144.00in	1	253.08
MHR-104206000	PVC Header-Smooth Crown (BNS) Custom Size	1	Quote
MHR-104106010	PVC Header-Smooth Crown 5.50in KEYSTONE-Typ:01	1	19.25

CAT: MHR
PVC HEADER 7.25" HEIGHT TYPE: MHR-1042 (3/4" BOARD W/RAMS CROWN, BULLNOSE EDGE)

PRODUCT NO.	DESCRIPTION	PACKAGING (per box)	PRICE (each)
MHR-104208024	PVC Header-Smooth Crown (BNS) 7.25x24.00in	1	71.79
MHR-104208030	PVC Header-Smooth Crown (BNS) 7.25x30.00in	1	82.15
MHR-104208036	PVC Header-Smooth Crown (BNS) 7.25x36.00in	1	92.51
MHR-104208042	PVC Header-Smooth Crown (BNS) 7.25x42.00in	1	102.87
MHR-104208048	PVC Header-Smooth Crown (BNS) 7.25x48.00in	1	113.22
MHR-104208054	PVC Header-Smooth Crown (BNS) 7.25x54.00in	1	123.58
MHR-104208060	PVC Header-Smooth Crown (BNS) 7.25x60.00in	1	133.94
MHR-104208066	PVC Header-Smooth Crown (BNS) 7.25x66.00in	1	144.30
MHR-104208072	PVC Header-Smooth Crown (BNS) 7.25x72.00in	1	154.65
MHR-104208078	PVC Header-Smooth Crown (BNS) 7.25x78.00in	1	165.01
MHR-104208084	PVC Header-Smooth Crown (BNS) 7.25x84.00in	1	175.37
MHR-104208096	PVC Header-Smooth Crown (BNS) 7.25x96.00in	1	196.08
MHR-104208108	PVC Header-Smooth Crown (BNS) 7.25x108.00in	1	216.80
MHR-104208120	PVC Header-Smooth Crown (BNS) 7.25x120.00in	1	237.51
MHR-104208144	PVC Header-Smooth Crown (BNS) 7.25x144.00in	1	278.94
MHR-104208000	PVC Header-Smooth Crown (BNS) Custom Size	1	Quote
MHR-104108010	PVC Header-Smooth Crown 7.25in KEYSTONE-Typ:01	1	25.38

For Custom Lengths specify length to the 1/4in and use the next largest size for price.
Optional Keystone: Same for SQR or BNS Edge

BNS - Bullnose



SPECIALTY PRODUCTS INC.

PVC Pilasters



PAINT SCH. CODE: 1B

CAT: MPL		FLUTED (FLUTE TEMPLATE FLT01) 5/8" MATERIAL	
PRODUCT NO.	DESCRIPTION	PACKAGING (per box)	PRICE (pair)
MPL-102106084	5.50x84.00in	1 pair	131.10
MPL-102106094	5.50x94.00in	1 pair	139.98
MPL-102108084	7.25x84.00in	1 pair	153.00
MPL-102108096	7.25x94.00in	1 pair	164.48
MPL-102110084	9.25x84.00in	1 pair	178.03
MPL-102110096	9.25x94.00in	1 pair	192.47
MPL-102112084	11.25x84.00in	1 pair	203.06
MPL-102112096	11.25x94.00in	1 pair	220.47
MPL-102100000	PVC Pilaster FLT1 CUSTOM	1 pair	Call for Quote
CAT: MPL		FLUTED (FLUTE TEMPLATE FLT02) 5/8" MATERIAL	
PRODUCT NO.	DESCRIPTION	PACKAGING (per box)	PRICE (pair)
MPL-102206084	5.50x84.00in	1 pair	131.10
MPL-102206094	5.50x94.00in	1 pair	139.98
MPL-102208084	7.25x84.00in	1 pair	153.00
MPL-102208096	7.25x94.00in	1 pair	164.48
MPL-102210084	9.25x84.00in	1 pair	178.03
MPL-102210096	9.25x94.00in	1 pair	192.47
MPL-102212084	11.25x84.00in	1 pair	203.06
MPL-102212096	11.25x94.00in	1 pair	220.47
MPL-102200000	PVC Pilaster FLT2 CUSTOM	1 pair	Call for Quote
CAT: MPL		FLUTED (FLUTE TEMPLATE FLT03) 5/8" MATERIAL	
PRODUCT NO.	DESCRIPTION	PACKAGING (per box)	PRICE (pair)
MPL-102306084	5.50x84.00in	1 pair	131.10
MPL-102306094	5.50x94.00in	1 pair	139.98
MPL-102308084	7.25x84.00in	1 pair	153.00
MPL-102308096	7.25x94.00in	1 pair	164.48
MPL-102310084	9.25x84.00in	1 pair	178.03
MPL-102310096	9.25x94.00in	1 pair	192.47
MPL-102312084	11.25x84.00in	1 pair	203.06
MPL-102312096	11.25x94.00in	1 pair	220.47
MPL-102300000	PVC Pilaster FLT3 CUSTOM	1 pair	Call for Quote

CAT: MPL		PLUNGE ROUTE (PLUNGE ROUTE TEMPLATE RP01) 5/8" MATERIAL	
PRODUCT NO.	DESCRIPTION	PACKAGING (per box)	PRICE (pair)
MPL-103106084	5.50x84.00in	1 pair	139.10
MPL-103106094	5.50x94.00in	1 pair	147.98
MPL-103108084	7.25x84.00in	1 pair	161.00
MPL-103108094	7.25x94.00in	1 pair	172.48
MPL-103110084	9.25x84.00in	1 pair	186.03
MPL-103110094	9.25x94.00in	1 pair	200.47
MPL-103112084	11.25x84.00in	1 pair	211.06
MPL-103112094	11.25x94.00in	1 pair	228.47
MPL-103100000	PVC Pilaster RP01 CUSTOM	1 pair	Call for Quote
CAT: MPL		PLUNGE ROUTE (PLUNGE ROUTE TEMPLATE RP02) 5/8" MATERIAL	
PRODUCT NO.	DESCRIPTION	PACKAGING (per box)	PRICE (pair)
MPL-103206084	5.50x84.00in	1 pair	139.10
MPL-103206094	5.50x94.00in	1 pair	147.98
MPL-103208084	7.25x84.00in	1 pair	161.00
MPL-103208094	7.25x94.00in	1 pair	172.48
MPL-103210084	9.25x84.00in	1 pair	186.03
MPL-103210094	9.25x94.00in	1 pair	200.47
MPL-103212084	11.25x84.00in	1 pair	211.06
MPL-103212094	11.25x94.00in	1 pair	228.47
MPL-103200000	PVC Pilaster RP02 CUSTOM	1 pair	Call for Quote
CAT: MPL		PLUNGE ROUTE (PLUNGE ROUTE TEMPLATE RP03) 5/8" MATERIAL	
PRODUCT NO.	DESCRIPTION	PACKAGING (per box)	PRICE (pair)
MPL-103306084	5.50x84.00in	1 pair	139.10
MPL-103306094	5.50x94.00in	1 pair	147.98
MPL-103308084	7.25x84.00in	1 pair	161.00
MPL-103308094	7.25x94.00in	1 pair	172.48
MPL-103310084	9.25x84.00in	1 pair	186.03
MPL-103310094	9.25x94.00in	1 pair	200.47
MPL-103312084	11.25x84.00in	1 pair	211.06
MPL-103312094	11.25x94.00in	1 pair	228.47
MPL-103300000	PVC Pilaster RP03 CUSTOM	1 pair	Call for Quote

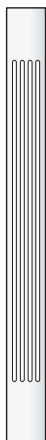

Fluted (Template FLT01)

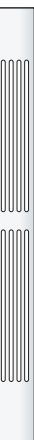
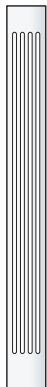

Fluted (Template FLT02)

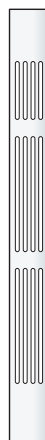

Plunge Route (Template RP01)

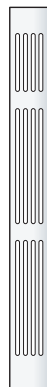

Plunge Route (Template RP02)



Plunge Route (Template RP03)



Plunge Route (Template RP03)



PVC Pilasters

CAT: MPL RECESSED PANEL (TYPE:REC-01) 5/8" FRAME, 3/8" PANEL MATERIAL			
PRODUCT NO.	DESCRIPTION	PACKAGING (per box)	PRICE (pair)
MPL-104106084	5.50x84.00in	1 pair	174.60
MPL-104106094	5.50x94.00in	1 pair	187.17
MPL-104108084	7.25x84.00in	1 pair	205.04
MPL-104108094	7.25x94.00in	1 pair	221.81
MPL-104110084	9.25x84.00in	1 pair	239.82
MPL-104110094	9.25x94.00in	1 pair	261.39
MPL-104112084	11.25x84.00in	1 pair	274.61
MPL-104112094	11.25x94.00in	1 pair	300.98
MPL-104100000	PVC Pilaster REC-01 CUSTOM	1 pair	Call for Quote
CAT: MPL RECESSED PANEL (TYPE:REC-02) 5/8" FRAME, 3/8" PANEL MATERIAL			
PRODUCT NO.	DESCRIPTION	PACKAGING (per box)	PRICE (pair)
MPL-104206084	5.50x84.00in	1 pair	174.60
MPL-104206094	5.50x94.00in	1 pair	187.17
MPL-104208084	7.25x84.00in	1 pair	205.04
MPL-104208094	7.25x94.00in	1 pair	221.81
MPL-104210084	9.25x84.00in	1 pair	239.82
MPL-104210094	9.25x94.00in	1 pair	261.39
MPL-104212084	11.25x84.00in	1 pair	274.61
MPL-104212094	11.25x94.00in	1 pair	300.98
MPL-104200000	PVC Pilaster REC-02 CUSTOM	1 pair	Call for Quote
CAT: MPL RECESSED PANEL (TYPE:REC-03) 5/8" FRAME, 3/8" PANEL MATERIAL			
PRODUCT NO.	DESCRIPTION	PACKAGING (per box)	PRICE (pair)
MPL-104306084	5.50x84.00in	1 pair	174.60
MPL-104306094	5.50x94.00in	1 pair	187.17
MPL-104308084	7.25x84.00in	1 pair	205.04
MPL-104308094	7.25x94.00in	1 pair	221.81
MPL-104310084	9.25x84.00in	1 pair	239.82
MPL-104310094	9.25x94.00in	1 pair	261.39
MPL-104312084	11.25x84.00in	1 pair	274.61
MPL-104312094	11.25x94.00in	1 pair	300.98
MPL-104300000	PVC Pilaster REC-03 CUSTOM	1 pair	Call for Quote

CAT: MPL		PVC PILASTER ACCESSORIES / OPTIONS	
PRODUCT NO.	DESCRIPTION	PACKAGING (per box)	PRICE (pair)
MPL-501000604	PVC Pilaster Plinth Block 5.50x3.50in H	1 pair	17.55
MPL-501000606	PVC Pilaster Plinth Block 5.50x5.50in H	1 pair	19.33
MPL-501000608	PVC Pilaster Plinth Block 5.50x7.25in H	1 pair	22.90
MPL-501000610	PVC Pilaster Plinth Block 5.50x9.25in H	1 pair	25.19
MPL-501000804	PVC Pilaster Plinth Block 7.25x3.50in H	1 pair	18.43
MPL-501000806	PVC Pilaster Plinth Block 7.25x5.50in H	1 pair	20.30
MPL-501000808	PVC Pilaster Plinth Block 7.25x7.25in H	1 pair	24.05
MPL-501008010	PVC Pilaster Plinth Block 7.25x9.25in H	1 pair	26.45
MPL-501001004	PVC Pilaster Plinth Block 9.25x3.50in H	1 pair	19.35
MPL-501001006	PVC Pilaster Plinth Block 9.25x5.50in H	1 pair	21.32
MPL-501001008	PVC Pilaster Plinth Block 9.25x7.25in H	1 pair	25.25
MPL-501001010	PVC Pilaster Plinth Block 9.25x9.25in H	1 pair	27.77
MPL-501001204	PVC Pilaster Plinth Block 11.25x3.50in H	1 pair	20.32
MPL-501001206	PVC Pilaster Plinth Block 11.25x5.50in H	1 pair	22.39
MPL-501001208	PVC Pilaster Plinth Block 11.25x7.25in H	1 pair	26.51
MPL-501001210	PVC Pilaster Plinth Block 11.25x9.25in H	1 pair	29.16
MPL-501000000	PVC Pilaster Plinth Block CUSTOM	1 pair	Call for Quote

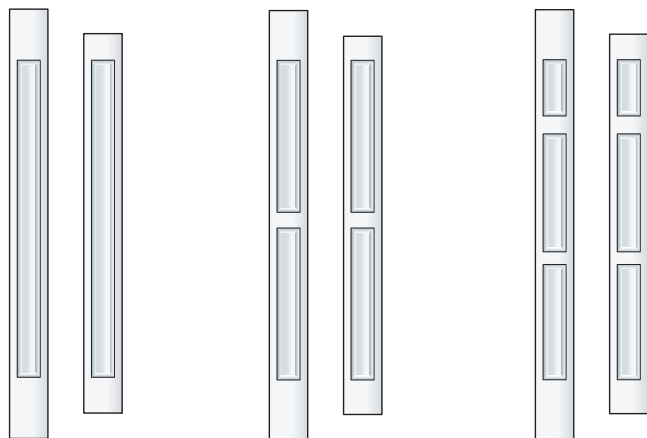

Recessed Panel (Template REC01)

Recessed Panel (Template REC02)

Recessed Panel (Template REC03)

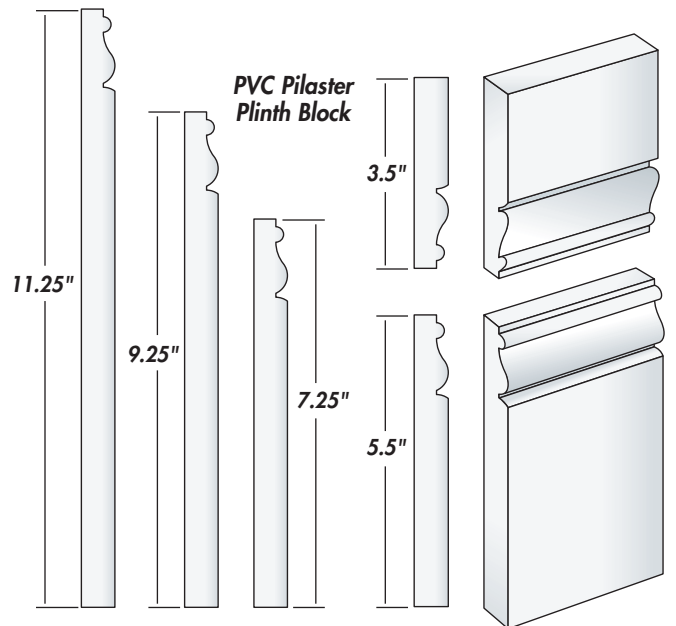

PVC Pilaster Plinth Block

PVC Mouldings

CAT: MMD		CROWN	
PRODUCT NO.	DESCRIPTION	PACKAGING (per box)	PRICE (each)
MMD-120105144	Crown 3.50in FRZ-2.75x5.00x144in	1	115.13
MMD-120107144	Crown 3.50in FRZ-2.75x7.00x144in	1	135.03
MMD-120110144	Crown 3.50in FRZ-2.75x10.00x144in	1	152.41
CAT: MMD		PVC MOULDING	
MMD-130050144	PVC Moulding 2.50x7.25x144in	1	157.40
MMD-140080096	PVC Moulding Fleur-De-Lis 7.50x96.0in	1	62.95
CAT: MMD		DENTIL FRIEZE	
MMD-151008144	Dentil Frieze 1.50x7.25x144in	1	135.88
MMD-151010144	Dentil Frieze 1.50x9.25x144in	1	155.79
MMD-151108144	Dentil Frieze-w/Bullnose 1.50x7.25x144in	1	154.38
MMD-151110144	Dentil Frieze-w/Bullnose 1.50x9.25x144in	1	162.15
MMD-152008144	Dentil Frieze 1.50x7.25x144in	1	135.88
MMD-152010144	Dentil Frieze 1.50x9.25x144in	1	155.79
MMD-152108144	Dentil Frieze-w/Bullnose 1.50x7.25x144in	1	142.24
MMD-152110144	Dentil Frieze-w/Bullnose 1.50x9.25x144in	1	162.15
MMD-153004144	Dentil Frieze 1.50x3.50x144in	1	81.47
MMD-153006144	Dentil Frieze 1.50x5.50x144in	1	101.38
MMD-153106144	Dentil Frieze-w/Bullnose 1.50x5.50x144in	1	107.74
MMD-153108144	Dentil Frieze-w/Bullnose 1.50x7.25x144in	1	125.11
MMD-154004144	Dentil Frieze 1.50x3.50x144in	1	112.81
MMD-154006144	Dentil Frieze 1.50x5.50x144in	1	130.18
MMD-154106144	Dentil Frieze-w/Bullnose 1.50x5.50x144in	1	119.17
MMD-154108144	Dentil Frieze-w/Bullnose 1.50x7.25x144in	1	135.54
MMD-151075048	Dentil Strip 0.75x5.50x48.00in	1	16.50
MMD-152075048	Dentil Strip 0.75x5.50x48.00in	1	14.60
MMD-153075048	Dentil Strip 0.75x5.50x48.00in	1	10.79
MMD-154075048	Dentil Strip 0.75x5.50x48.00in	1	16.50

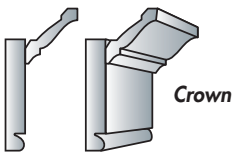

Crown

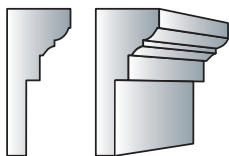

PVC Moulding



Dentil Strip - MMD-154075048



Dentil Frieze-w/Bullnose - MMD-154106144



Dentil Frieze-w/Bullnose - MMD-154108144

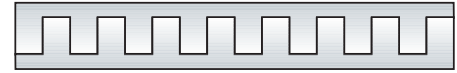

Dentil Frieze
MMD-120110144 / MMD-120110144



Fleur-De-Lis - MMD-140080096



Dentil Strip - MMD-151075048

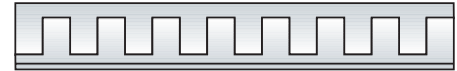

Dentil Frieze-w/Bullnose
MMD-151108144 / MMD-120110144



Dentil Frieze
MMD-152008144 / MMD-152010144



Dentil Strip - MMD-152075048



Dentil Frieze-w/Bullnose
MMD-152108144 / MMD-152110144



Dentil Frieze - MMD-153004144



Dentil Frieze - MMD-153006144



Dentil Strip - MMD-153075048



Dentil Frieze-w/Bullnose - MMD-153106144



Dentil Frieze-w/Bullnose - MMD-153108144



Dentil Frieze - MMD-154004144



Dentil Frieze - MMD-154006144

Make the **ULTIMATE** First Impression in your neighbourhood!

www.valor.ca

VALOR SPECIALTY PRODUCTS INC.

1800 Courtneypark Dr. East, Units 2-4
Mississauga, ON Canada L5T 1W1

TEL: (905) 564-3122 • FAX: (905) 564-5470

PVC Brackets & Accents

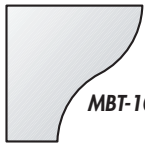

MBT-102040404

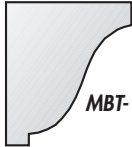

MBT-103060606

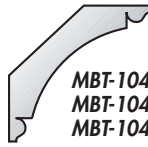

MBT-104141430
MBT-104161630
MBT-104181830

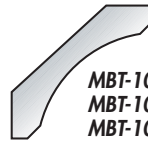

MBT-105121220/30
MBT-105141420/30
MBT-105181820/30

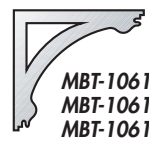

MBT-106121215
MBT-106141415
MBT-106161615

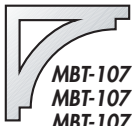

MBT-107121215
MBT-107141415
MBT-107161615



MBT-108141050
MBT-108142250
MBT-108142450

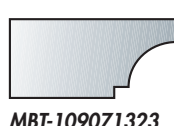

MBT-109071323

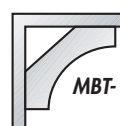

MBT-10101010

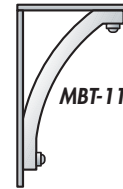

MBT-110152404



MBT-111155110



MBT-112091330

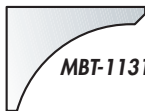

MBT-113152030

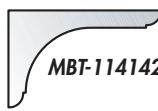

MBT-114142240



MBT-115151404

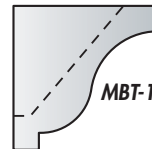

MBT-116090903

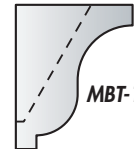

MBT-116110903



MBT-201171508



MBT-202091508
MBT-202122008



MBT-203231608



MBT-204362108



MBT-205121208

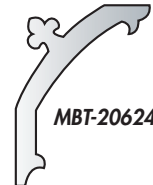

MBT-206241808



MBT-207162908



MBT-208221208



MBT-209103108



MBT-210072408



MBT-211123008

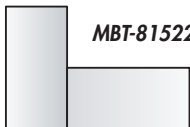

MBT-815225096

PVC Brackets & Accents



CAT: MBT			
BRACKETS & ACCENTS			
PRODUCT NO.	DESCRIPTION	PACKAGING (per box)	PRICE (each)
MBT-101010010	PVC Bracket-Solid 10x10x3.5 in.	1	26.70
MBT-102040404	PVC Bracket 4.0x4.0x4.0in	1	30.34
MBT-103060606	PVC Bracket 5.50x6.25x5.50in	1	40.64
MBT-104141430	PVC Bracket-Solid 14x14x3.0 in.	1	56.85
MBT-104161630	PVC Bracket-Solid 16x16x3.0 in.	1	74.23
MBT-104181830	PVC Bracket-Solid 18x18x3.0 in.	1	93.97
MBT-105121220	PVC Bracket-Solid 12x12x2.00 in.	1	33.04
MBT-105141420	PVC Bracket-Solid 14x14x2.00 in.	1	34.71
MBT-105181820	PVC Bracket-Solid 18x18x2.00 in.	1	46.68
MBT-105121230	PVC Bracket-Solid 12x12x3.00 in.	1	41.30
MBT-105141430	PVC Bracket-Solid 14x14x3.00 in.	1	43.39
MBT-105181830	PVC Bracket-Solid 18x18x3.00 in.	1	58.35
MBT-106121215	PVC Bracket-Solid 12x12x1.5 in.	1	31.57
MBT-106141415	PVC Bracket-Solid 14x14x1.5 in.	1	42.97
MBT-106161615	PVC Bracket-Solid 16x16x1.5 in.	1	56.12
MBT-107121215	PVC Bracket-Solid 12x12x1.5 in.	1	31.57
MBT-107141415	PVC Bracket-Solid 14x14x1.5 in.	1	42.97
MBT-107161615	PVC Bracket-Solid 16x16x1.5 in.	1	56.12
MBT-108141050	PVC Rafter End-Hollow 14x10x5 in.	1	98.42
MBT-108142250	PVC Rafter End-Hollow 14x22x5 in.	1	143.86
MBT-108142450	PVC Rafter End-Hollow 14x24x5 in.	1	156.94
MBT-109071323	PVC Rafter End-Hollow 7x13.5x2.25 in.	1	34.26
MBT-110152404	PVC Bracket-Solid 15.0x24x3.50in	1	67.69
MBT-111155110	PVC Bracket-Beam/Column 14.5x50.5x0.75in	1	78.46
MBT-112091330	PVC Bracket-Hollow 9.25x13.00x3.00in	1	75.70
MBT-113152030	PVC Bracket-Hollow 15.00x20.00x3.00in	1	89.62
MBT-114142240	PVC Bracket-Hollow 14.00x22.00x4.00in	1	61.31
MBT-115141504	PVC Bracket-Hollow 15.0x13.5x3.50in	1	72.17
MBT-116090903	PVC Bracket-Hollow 8.5x8.5x3.0in	1	40.58
MBT-116110903	PVC Bracket-Hollow 10.5x8.5x3.0in	1	44.64

CAT: MBT			
BRACKETS & ACCENTS			
PRODUCT NO.	DESCRIPTION	PACKAGING (per box)	PRICE (each)
MBT-201171508	PVC Bracket-Solid 16.9x15.4x0.75 in.	1	43.25
MBT-202091508	PVC Bracket-Solid 8.5x14.9x0.75 in.	1	21.47
MBT-202122008	PVC Bracket-Solid 11.6x20.4x0.75 in.	1	40.07
MBT-203231608	PVC Bracket-Solid 23.4x16.1x0.75 in.	1	59.90
MBT-204362108	PVC Bracket-Solid 36.1x20.8x0.75 in.	1	89.54
MBT-205121208	PVC Bracket-Solid 12x12x0.75 in.	1	22.90
MBT-206241808	PVC Bracket-Solid 24x17.8x0.75 in.	1	50.94
MBT-207162908	PVC Bracket-Solid 16x29x0.75 in.	1	55.33
MBT-208221208	PVC Gable Trim-Solid 22x12x0.75 in.	1	41.98
MBT-209103108	PVC Gable Trim-Solid 10.2Xx31.4x0.75 in.	1	50.92
MBT-210072408	PVC Gable Trim-Solid 6.5x23.9x0.75 in.	1	24.70
MBT-211123008	PVC Gable Trim-Solid 11.7X3x30x0.75 in.	1	41.86
MBT-815225096	PVC Bracket/Scroll Channel 1.50x2.25x96.00in	1	27.53

Make the ULTIMATE First Impression in your neighbourhood!

www.valor.ca

VALOR SPECIALTY PRODUCTS INC.

1800 Courtneypark Dr. East, Units 2-4
Mississauga, ON Canada L5T 1W1

TEL: (905) 564-3122 • FAX: (905) 564-5470

Custom PVC Products

- Virtually any custom shape can be produced with the correct measurements.
- Products can be multi-layered and profiled parts
- Some Items may require Framing Templates
- All products will be quoted on an individual basis.

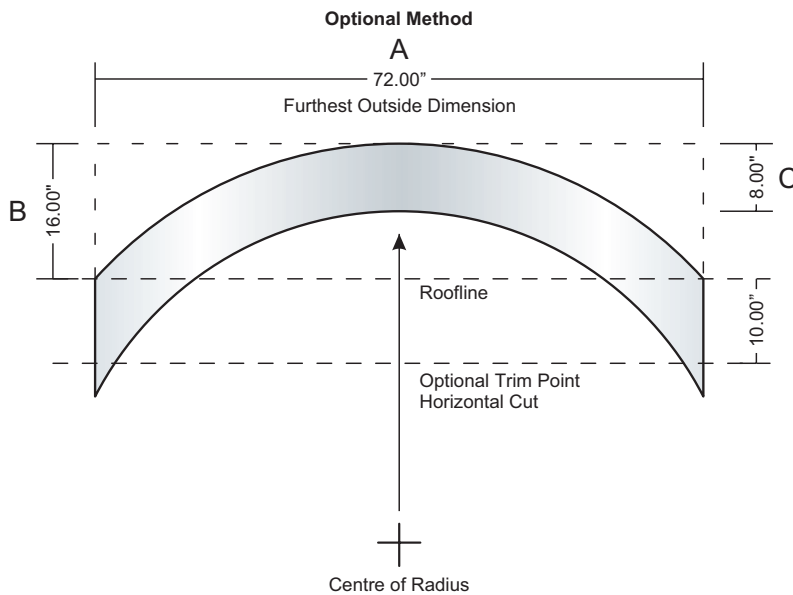
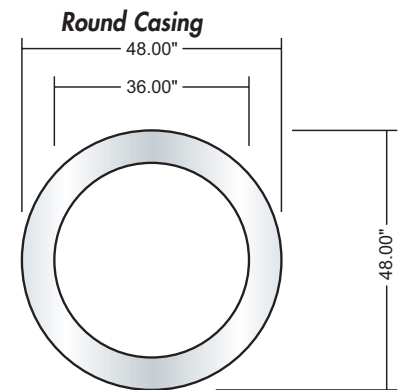
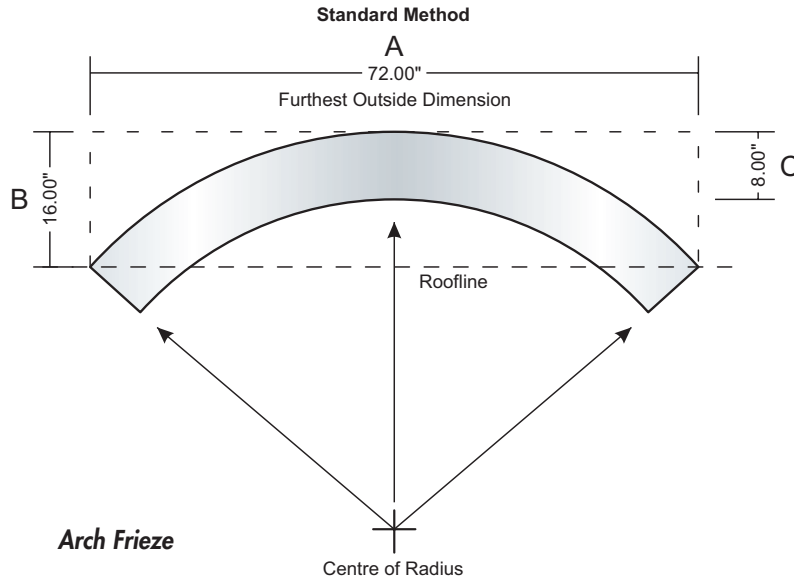

Make the ULTIMATE First Impression in your neighbourhood!

www.valor.ca

VALOR SPECIALTY PRODUCTS INC.

1800 Courtneypark Dr. East, Units 2-4
Mississauga, ON Canada L5T 1W1

TEL: (905) 564-3122 • FAX: (905) 564-5470

Custom PVC Products

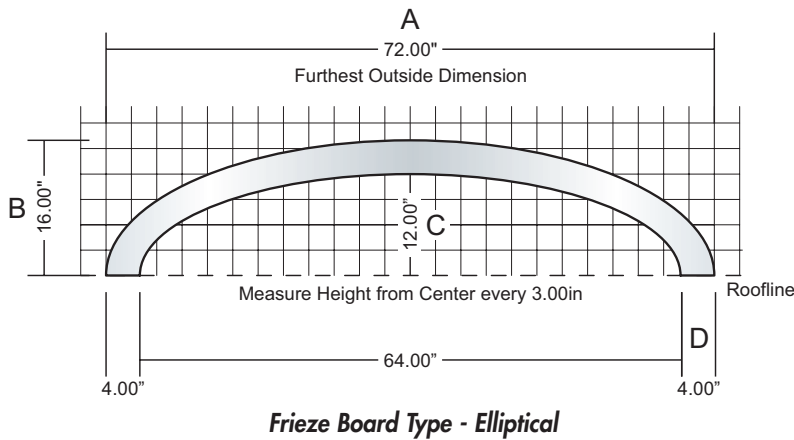

**Round Top
Custom Curved
Gable Fascia Board**

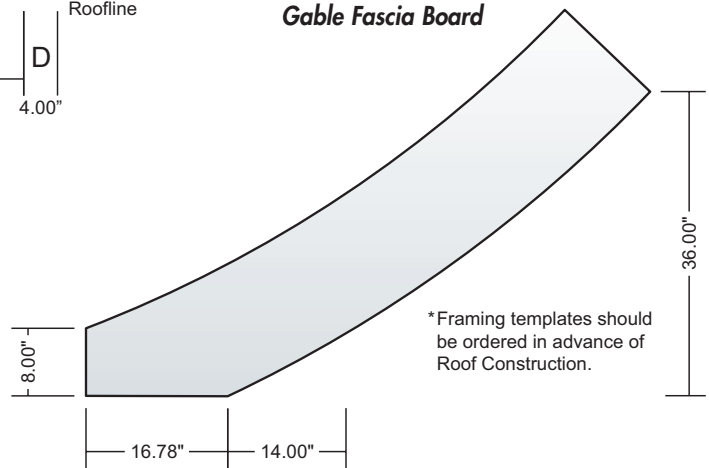

PVC Cladding
Beam Applications

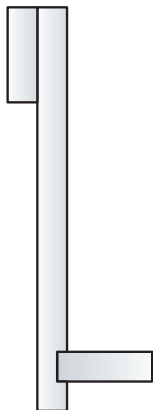

PVC Cladding
Beam Applications

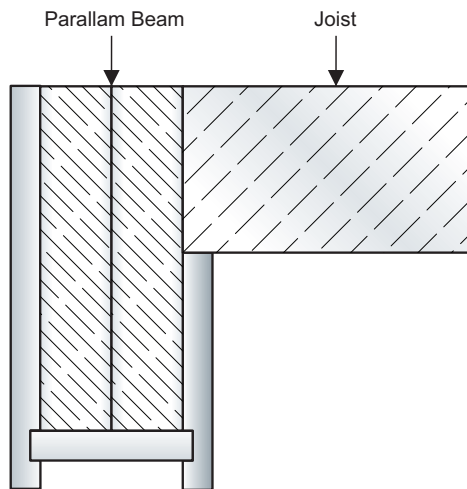

PVC Cladding
Facade

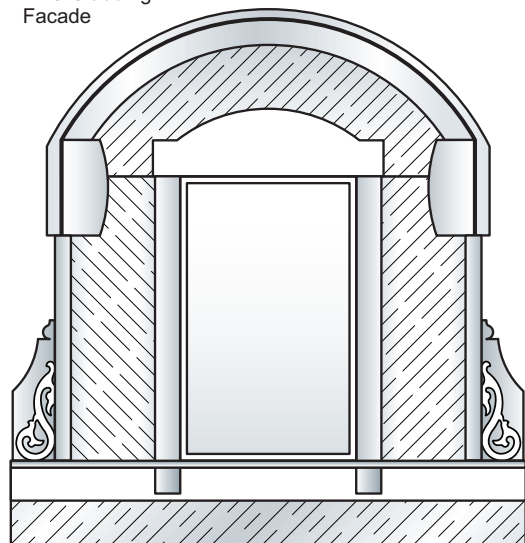

Make the ULTIMATE First Impression in your neighbourhood!

www.valor.ca

VALOR SPECIALTY PRODUCTS INC.

1800 Courtneypark Dr. East, Units 2-4
Mississauga, ON Canada L5T 1W1

TEL: (905) 564-3122 • FAX: (905) 564-5470

VALOR

SPECIALTY PRODUCTS INC.



Paint Services

Paint

Valor uses only Low VOC (volatile organic content) waterbase paint. We've selected paint specifically developed to provide superior adhesion to plastic substrates and hardness. Valor has applied this product since 2006 with excellent results.

Process

All products go through a multi-stage preparation process to ensure correct adhesion to the product.

Application

Valor utilizes the most advance HVLP guns for application of paint. Some colour pigments require multiple wet coats where each coat needs to fully flash off before the next coat can be applied. Some colours will be applied at a premium to cover any additional costs.

Heat Reflective

Darker colours will have a heat reflective additive to reduce surface temperatures intended to reduce warping and expansion.

Gloss Level

Our paint is ordered with a 60% gloss, although we have specified large projects using material with larger surface area in MATT finish that would be approximately at 40% gloss.

Protection

All painted product is protected as required, with poly wrap, self-adhesive film, foam, or cardboard.

Minimum Charge

The minimum Charge applies to each colour ordered. If the total square feet, or flat rate paint charges do not meet or exceed the minimum charge then the minimum charge will be billed.

Core Colours (\$35.00/ Single Colour)

These are generally colours that are requested frequently and as a result we generally use this paint quickly. Please contact our office for current core colours. We will add core colours that may be requested regularly.

Non-Core Colours (\$95.00/ Single Colour)

These are colours that are not requested frequently and a result some paint ordered my need to be discarded.

Paint Match

We can match any colour however due to match cost and the amount of paint required, we will charge a paint match fee.

Projects

Projects that will use greater than a gallon of paint will generally not have extra charges, however minimum charges will always apply.

Paint Schedule

Due to the type of material, the amount of prep required, and the shape of the product, one of several different paint schedules will be applied to each product or product category. Please contact our office to determine the schedule and the correct method of calculating the charge.

PAINT APPLICATIONS			
PRODUCT NO.	DESCRIPTION	UNIT	PRICE
VLR-SERPT01A	Paint Application - 1A*	SQ.FT.	2.00
VLR-SERPT01B	Paint Application - 1B*	SQ.FT.	2.50
VLR-SERPT01C	Paint Application - 1C*	SQ.FT.	4.50
VLR-SERPT01D	Paint Application - 1D*	SQ.FT.	6.50
VLR-SERPT02A	Paint Application - 2A**	SQ.FT.	3.00
VLR-SERPT02B	Paint Application - 2B**	SQ.FT.	4.50
VLR-SERPT02C	Paint Application - 2C**	SQ.FT.	6.50
VLR-SERPT02D	Paint Application - 2D**	SQ.FT.	10.00
VLR-SERPT03A	Paint Application - 3A /PC (0-0.9 Sq.ft)***	SQ.FT.	2.00
VLR-SERPT03B	Paint Application - 3B /PC (1-1.9 Sq.ft)***	SQ.FT.	4.00
VLR-SERPT03C	Paint Application - 3C /PC (2-2.9 Sq.ft)***	SQ.FT.	6.00
VLR-SERPT03D	Paint Application - 3D /PC (3-3.9 Sq.ft)***	SQ.FT.	8.00
VLR-SERPT09A	Paint Match Fee	EA.	50.00
VLR-PNT10030	Paint Touch Up Bottle (30ml)	EA.	5.00
VLR-PNT10350	Paint Touch Up Bottle (350ml)	EA.	25.00

Visit [website](http://www.valor.ca) for all current paint colour offerings

FOR A LIST OF CURRENT AVAILABLE COLOUR MATCHES: visit www.valor.ca/resources.html

* Items processed under 1A Pricing will have their SQ.FT. calculated based on front facing dimensions, and Items will be rounded up to full SQ.FT.

** Items processed under 2A Pricing will have all painted surfaces calculated into total SQ.FT., and Items will be rounded up to full SQ.FT.

*** Items processed under /PC Pricing will be billed at max. SQ.FT. (i.e. a 3A item with less than 1 Sq.ft. will be billed at 1 SQ.FT.

(Some Paint projects, due to additional preparation, product configuration, and colour selected may require a premium.)

Make the ULTIMATE First Impression in your neighbourhood!

www.valor.ca

VALOR SPECIALTY PRODUCTS INC.

1800 Courtneypark Dr. East, Units 2-4
Mississauga, ON Canada L5T 1W1

TEL: (905) 564-3122 • FAX: (905) 564-5470

VALOR

SPECIALTY PRODUCTS INC.

Terms & Conditions

Orders

Custom & Special Order Goods

Orders for custom made goods cannot be cancelled or altered 24 hours after the order has been placed. No custom made goods are eligible for return. Valor may require partial of full payment of some custom made product orders.

Stock Goods

Non-custom made items require advance approval from our office for return, a return authorization number and packing list will be provided to you once approved to use as a packing slip. Items that had been special ordered from a supplier specifically for an order are NOT eligible for return. All return freight charges or other charges will be the responsibility of our customer. Valor may require photographs of product before considering a return authorization. Product purchased more than 6 months prior may not be eligible for return, nor will any product that is no longer maintained as regular stock. A 20% re-stocking charge (charges on the value of the product only) will be applied to ANY returned goods.

Product Specifications

Valor is constantly making product improvements and as a result we reserve the right to adjust product specifications, and/or materials without notice.

Shipments

All shipments leave our plant with a packing slip. Discrepancies in quantity, etc., should be reported to us immediately. We may need to track a partial shipment, the order may have been split shipped by our carrier, or perhaps a mistake was made. Shipment variances not reported within 7 days of shipping date will be considered a complete and correct shipment.

Freight / Shipping

All prices quoted are F.O.B. our plant unless notified otherwise in writing, from an authorized representative of Valor Specialty Products Inc. Freight minimums to qualify for prepaid freight on a product category basis will be provided in writing, and may be modified from time to time, although customers will be notified in advance of any such changes to our policies.

Should your orders not meet any predefined minimums to qualify for prepaid freight, we will prepay and bill you for the freight. You may pick your orders up however we prefer to use our own carriers for shipping efficiency; should you wish to have us use your carrier a \$25.00 fee will apply. We will endeavor to determine your requirements of us in respect to less than prepaid shipments, i.e. call in advance, call for authorization, etc.

Freight Damage

It is the responsibility of the Customer receiving the goods to inspect before signing for the goods. If there is visible damage, the Receiver MUST, make a notation of the Bill of Lading or and Document that the Carrier requires signed that there was "Damages". If the Good's we shipped with a Carrier designated by the Customer, and/ was shipping Collect; it is the Customers responsibility to contact the carrier for an inspection and issue a freight claim. **THE GOODS MUST BE MADE AVAILABLE FOR INSPECTION REGARDLESS OF WHO IS RESPONSIBLE FOR THE DAMAGE.** If the goods were as a Prepaid Shipment / or Was shipped Prepaid and we billed the freight on our Invoice, then it is our responsibility to contact the Carrier for an Inspection and issue the freight claim. **THE GOODS MUST BE MADE AVAILABLE FOR INSPECTION.**

Any Noticeable Damage must be reported to either the Carrier or Valor within 24 Hours of Receiving the Shipment.

Freight Damage

Any Concealed Damage resulting from the shipping of goods MUST be reported to Valor within 15 Days of a Shipment. Any report of Damage beyond that period will not be considered Freight Damage.

Valor may require photos of the product as well as the Shipping Carton in order to ascertain the nature of the damage. Any Damages that are beyond 30 Days for the date of the shipment will not be considered as a Damage Claim; Valor will elect to repair the goods or reject the possibility of repair in which case replacement product may have to be purchased. In no cases will Valor issue a credit or take a return of any Damaged product that is not being replaced.

Invoices

Should any invoice have incorrect pricing, quantities, etc., please report them to our office right away. Valor will typically credit the initial invoice completely, and then re-bill with the correct values. **DO NOT TAKE UNAUTHORIZED DEDUCTIONS FROM OUR INVOICES**, to ensure your account is maintained and applied correctly.

Make the ULTIMATE First Impression in your neighbourhood!

www.valor.ca

VALOR SPECIALTY PRODUCTS INC.

1800 Courtneypark Dr. East, Units 2-4
Mississauga, ON Canada L5T 1W1

TEL: (905) 564-3122 • FAX: (905) 564-5470

VALOR

SPECIALTY PRODUCTS INC.

Terms & Conditions

**Taxes**

Should you be charged for any taxes that do not apply to you, please inform us immediately. We will issue a credit for the taxes charged. It may be necessary to have a tax exemption certificate completed.

Pricing

Our pricing is subject to change without notice.

Warranties

Valor Specialty Products Inc. honors all manufacturer warranties for the products we offer. Valor will not be liable for any product failures, but will facilitate the repair or replacement of any applicable manufacturer's warranty per their terms. Valor will abide by the specific treatment of the warranty claim as specified by our supplier. Product inspection may be required by a factory (supplier) representative, and Valor authorized representative or an authorized dealer of Valor, which is to be determined co-operatively between Valor and our supplier.

Payment Terms

Those customers who may buy on a regular basis should apply for an account, and a Credit Application will be provided. Once received we will perform our credit checks and due diligence and will advise the customer in writing as to the outcome and the amount of credit and the payment period authorized (if approved). All customers will be required to fill out a basic information form to capture basic company information so that we can set up the account correctly, regardless of payment terms.

Overdue Accounts

Interest will be charged on overdue accounts in the amount of 2.5% per month. Any and all legal costs, fees, charges, travel expenses, shipping, etc., will also be charged to any account where legal action is necessary to settle the account.

Make the ULTIMATE First Impression in your neighbourhood!

www.valor.ca

VALOR SPECIALTY PRODUCTS INC.

1800 Courtneypark Dr. East, Units 2-4
Mississauga, ON Canada L5T 1W1

TEL: (905) 564-3122 • FAX: (905) 564-5470



VALOR

SPECIALTY PRODUCTS INC.

Maintenance Free...

- Custom Decorative Shutters
- Fiberglass Columns
- Exterior Mouldings
- Siding Accessories
- PVC Millwork



Make the ULTIMATE First Impression in your neighbourhood!

www.valor.ca

VALOR SPECIALTY PRODUCTS INC.

1800 Courtneypark Dr. East, Units 2-4

Mississauga, ON Canada L5T 1W1

TEL: (905) 564-3122 • FAX: (905) 564-5470